

SOLZAIMA

SOLUÇÕES DE AQUECIMENTO A BIOMASSA

Pellet Stove

English

Instruction Manual

Models

Hidro 12

Hidro 17

Hidro 23

Read these instructions carefully before installing, using and servicing the unit. This instruction manual is provided with the product.

Mod. 1016-B

Thank you for purchasing a SOLZAIMA appliance.

Please read this manual carefully and retain it for future reference.

* All our products fulfil the requirements of the Construction Products Directive (Reg. UE nº 305/2011) and have been approved with the CE conformity mark;

* The Pellet Burning Free Standing Fires are designed according to EN 14785:2008 Standards;

* SOLZAIMA disclaims any responsibility for damages to the unit if installed by non-qualified personnel;

* SOLZAIMA is not responsible for any damage to units not installed and used in compliance to the instructions included in this manual;

* All local regulations, including but not limited to national and European standards, must be observed when installing, operating and servicing the unit;

* For assistance, please contact your unit's supplier or installer. You must have the wood pellet stove serial number located on the identification plate on unit's back panel and on the sticker on the plastic cover of this manual ready;

*The technical service must be performed by the unit Installer or Supplier, except on situations where the assessment performed by the installer or service engineer determines that SOLZAIMA should be contacted, if required.

* If you need more information about the electronics applied in the SOLZAIMA equipment you can scan the following QR Codes.



[Columbus Electronics](#)



[Not applicable Columbus Electronics](#)

Contacts for technical support:



www.solzaima.pt

apoio.cliente@solzaima.pt

Address: Rua da Cova da Areia (E.M. 605), 695;

3750-071 Aguada de Cima, Águeda – Portugal

Contents

1.	Package content	1
1.1.	Unpacking the unit.....	1
2.	Safety precautions 	2
2.1.	For your safety, we recommend that:	2
3.	Advice on action in the event of a fire in a chimney (includes equipment)	4
4.	Technical specifications	5
5.	Installing the free-standing <i>pellet</i> fire	9
5.1.	Installation requirements	10
5.2.	Installation of ducts and fume extraction systems	10
5.3.	Installation without a chimney	11
5.4.	Installation with a chimney	15
6.	Hydraulic Installation	16
6.1.	Operating mode for radiator/buffer tank	16
7.	Fuel.....	17
8.	Using the Free-Standing Pellet Fire	18
9.	Remote Control.....	20
9.1.	Remote control and display	20
9.1.	Display information summary	21
9.1.1.	Menu	21
9.1.2.	Water temperature	22
9.1.3.	Date	22
9.1.4.	Timer	25
9.1.5.	Sleep (this menu is displayed only while the unit is operating)	29
9.1.6.	Info	30
9.1.7.	Settings Menu	33
9.1.8.	Technical Menu	37
10.	Alarm/ Failure / Recommendation List 	39
11.	Control Columbus	41
11.1.	Display	41
11.2.	Settings Menu	42
11.2.1.	Language.....	42
11.2.2.	Time and Date.....	44
11.2.3.	Summer-Winter (not applicable)	46
11.3.	Display Menu.....	47
11.3.1.	Contrast.....	48
11.3.2.	Min Brightness.....	48
11.3.3.	Screen Saver.....	49

11.3.4.	Firmware Codes	49
11.4.	Service Menu	50
11.4.1.	Counters	51
11.4.2.	Error List	51
11.4.3.	Secondary Information	52
11.4.4.	Cleaning Reset	53
11.4.5.	Auger Calibration	54
11.4.6.	Fan Calibration	55
11.4.7.	Automatic Power	55
11.4.8.	Manual Load	56
11.5.	Power Menu	57
11.5.1.	Pellet	57
11.6.	Thermostats Menu	58
11.7.	Chrono Menu	59
11.8.	Info Menu	64
12.	Alarm / Failure / Recommendation List – Columbus Control	66
13.	Operating the unit	69
13.1.	Stop	69
13.2.	Turning off the unit	69
14.	Instruction for installing the casings	70
14.1.	Installation of the casings Hidro 12	70
14.2.	Installation of the casings Hidro 17 and Hidro 23	74
14.2.1.	Casings Fuji Oak, Himalaia and K2	76
14.2.2.	Casings Douro	78
14.3.	Pellet reservoir lid	81
14.4.	Filling the pellet reservoir	81
15.	Installation and operation with the remote control (chrono-thermostat) – not included in free standing units	82
15.1.	Instructions for remote control assembly	83
16.	Maintenance	86
16.1.	Daily Maintenance	86
16.2.	Weekly Maintenance	86
16.3.	Additional cleaning	90
16.4.	Cleaning the glass	94
17.	Maintenance Plan and Log	95
18.	Maintenance Guide Level	99
19.	Installation Diagrams	100
20.	Electrical diagram of the Free-Standing Pellet Fire unit	104
20.1.	Electrical diagram – Not applicable to Columbus electronics	104
20.2.	Electrical diagram – Applicable to Columbus electronics	105

21.	Hydraulic Pumps	106
21.1.	UPM3 FLEX AS 15-70 130mm	106
21.2.	Pump Wilo 15-130/7-50.....	108
22.	Life Cycle of a Free-Standing Fire Unit	116
23.	Sustainability.....	116
24.	Warranty.....	117
24.1.	Model-specific conditions.....	117
24.2.	Warranty general conditions	117
25.	Annexes.....	126
25.1.	Timer weekly programming (Not applicable to Columbus electronics)	126
25.2.	Flow chart Hidro 12	127
25.3.	Flow chart Hidro 17 and Hidro 23	130
25.4.	Statement of Performance.....	133

Solzaima

Solzaima's vision has always been clean, renewable and more economical energy. For this reason, we have been manufacturing biomass heating equipment and solutions for more than 45 years.

Fruit of the persistence and the unconditional support of its network of partners, Solzaima is today leader in the production of biomass heating, whose best examples are the recuperators of central heating to water and its range of salamanders to *pellets*.

We annually equip more than 20.000 homes with biomass heating solutions. It signals that consumer are aware of the most environmentally friendly and economical solutions.

Solzaima has ISO9001:2015 Quality Certification and ISO14001:2015 Environmental Certification.

1. Package content

Solzaima ships the unit with the following components:

- Free standing pellet fire model Hidro 12 kW, Hidro 17 kW or Hidro 23 kW;
- Access to the brochure of the online manual;
- Power cable.

1.1. Unpacking the unit

When unpacking the unit, please refer to the illustrations below. First remove the retractable bag containing the cardboard box. Then pull the cardboard box out (Figure 1-a) by lifting it and remove the bag containing the free-standing fire unit and the Styrofoam plates. Finally, unscrew the four parts securing the unit to the wood pallet (Figure 1-b and Figure 1-c).



a)



b)



c)

Figure 1 - Unpacking the free-standing fire unit

2. Safety precautions

Solzaima is not liable for any damages to the unit if the specified precautions, warnings and operating procedures are not followed.

Units manufactured by Solzaima are easy to operate and special attention was given to their components in order to protect users and installers against accidental damages.

The units must only be installed by an authorised engineer, who should supply the client with a relevant statement of conformity and who shall be liable for the final installation and consequent product good operating conditions.

This unit must be used according to its intended use as specified by the manufacturer. The manufacturer is excluded from all liability, by contract or by tort, caused by injury to people, animals or property arising from misuse or faulty installation or servicing.

After removing the packaging, verify the contents to check their integrity and completeness. If the content of the package fails to correspond to that indicated in point 1, contact the salesperson from whom you purchased the unit.

All the unit's components guarantee its operation and energy efficiency and should only be replaced with original parts provided by an authorised technical assistance centre.

The unit must be serviced at least once a year by the installation engineer.

This manual is provided with the product. Please keep it close to the unit.

2.1. For your safety, we recommend that:

Make sure you fully read and understand this instruction manual before using the free-standing pellet fire as a biomass heating unit;

- Make sure that the hydraulic circuit was correctly assembled and connected to the water supply before turning on the free-standing pellet fire;
- The free-standing pellet fire is not intended for use by children or persons with reduced physical, sensory or mental capabilities, or lack of experience or knowledge, unless they are under supervision or have been instructed concerning the use of the unit;
- Do not touch the free-standing fire when barefoot or if any part of your body is wet or humid;
- Do not tamper with safety or adjustment features without the manufacturer's authorization;
- Do not cover or reduce the size of the vents at the installation area;

- The free-standing pellet fire requires a clear space around the unit for proper combustion, so possible air tightness of the location or any existing air extraction sources in the room may prevent the unit proper operation;
- The existence of vents is a requisite for proper combustion;
- Do not leave the packing materials near children;
- During normal operation, Free Standing Fire unit's door must not be opened;
- Some parts of the unit may overheat during normal operation, so avoid direct contact with parts such as the door handle and glass;
- Check the existence of any obstructions on the fume duct before turning on the unit after a long period of inactivity;
- This free-standing pellet fire unit is intended for residential use in protected areas. Safety systems may turn off the unit. If this occurs, contact the technical assistance. In any circumstances should you attempt to interfere with the safety systems;
- The free-standing pellet fire is a biomass heating unit equipped with an electric fume extractor. The occurrence of any power failure during its use may prevent fume extraction and the room will be filled with smoke. For this reason, you should have a natural fume extraction system, like a chimney, available;
- Solzaima offers you an optional safety system which allows the Free-Standing Fire unit to be connected to a UPS so that during any power failure the fume extractor will still operate until complete extraction of all the fumes;
- If you intend to use the Free-Standing Fire unit while you are away from home or unattended, you should use the safety system specified above for total safety during any power failure;
- During operation, NEVER turn off the free-standing fire unit by disconnecting the electric plug. The fume extractor on the free-standing pellet fire unit is electric so disconnecting the power plug will prevent the extraction of combustion fumes;
- Your unit must be disconnected from the mains for servicing. Before doing this, the unit must be totally cooled down (if operating before);
- Never touch the interior of the unit without disconnecting it from the power mains;
- On back boiler models, the maximum temperature of the water that can be set by the user (water set-point temperature) is 85°C. In the event of a temperature of 90°C being reached, the free-standing pellet fire unit automatically disconnects and the respective alarm is activated.

3. Advice on action in the event of a fire in a chimney (includes equipment)

Try to extinguish the fire without putting your life at risk.

- If within a minute you cannot extinguish the fire, you should call the fire department.
- Close the doors and windows or partition where the fire has flared.
- Disconnect the electric current and close the gas before leaving your home.
- Once outside, you must wait for the firefighters and be ready to give you the following information: location of the fire, possible materials that are burning and what they can do to prevent the progression of fire.

4. Technical specifications

Features	Hidro 12	Hidro 17	Hidro 23	Un
Weight	185	202	219	kg
Height	1110	1192	1255	mm
Width	617	W	W	mm
Depth	707	710	767	mm
Diameter of the fume discharge pipe	80	100	100	mm
Reservoir capacity	30	36	55	kg
Maximum heating capacity	295	380	502	m ³
Maximum overall thermal power (water/air)	11,5 / 1,5	14,5 / 2,2	18,8 / 3,3	kW
Minimum thermal power (water/air)	3,8 / 1,2	4,3 / 0,8	4,3 / 0,8	kW
Minimum fuel consumption	1,1	1,1	1,1	kg/h
Maximum fuel consumption	3,0	3,9	5,1	kg/h
Rated electric power	43	134	134	W
Electric power at start-up (<10 min.)	406	434	434	W
Rated voltage	230	230	230	V
Nominal frequency	50	50	50	Hz
Thermal yield at rated thermal power	92,0	90,9	89,2	%
Thermal yield at reduced thermal power	95,0	93,8	93,8	%
Combustion gas flow (max.)	21,0	6,9	6,9	g/s
Combustion gas flow (min.)	44,0	33,7	18,8	g/s
Max. gas temperature	108	126,5	153,4	°C
Min. gas temperature	62	66	66	°C
CO emissions at rated thermal power	0,0136	0,0162	0,0200	%
CO emissions at reduced thermal power	0,0256	0,0200	0,0200	%
Draught in the chimney	12	12	12	Pa
Unit water volume	19	22	22	L
Rated electric power	49,1	49,1	49,1	dB(A)

Table 1 - Technical specifications

Tests performed using wood pellets with a heating capacity of 4,9 kWh/kg.

The above information was obtained during product homologation tests performed at independent laboratories accredited for pellet unit tests.

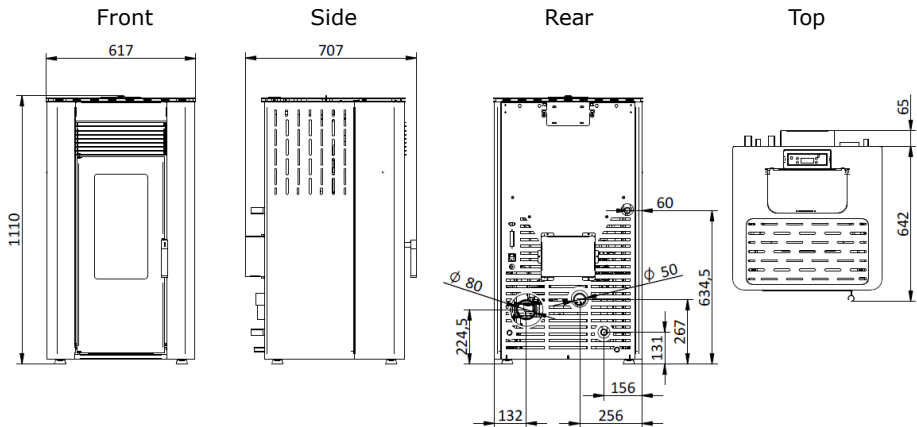


Figure 2 - Dimensions of the free-standing pellet fire unit Hidro 12

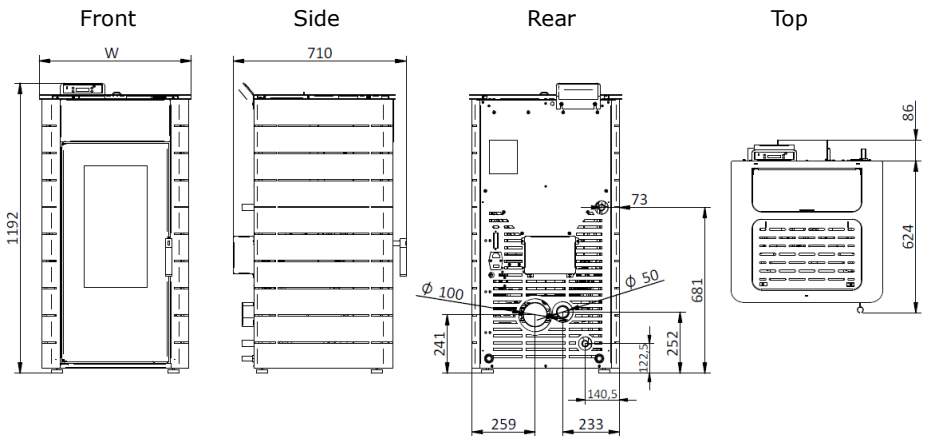


Figure 3 - Dimensions of the free-standing pellet fire unit Hidro 17 (Himalaia)

Model	Douro	Fuji	Himalaia	K2
Dimension "W" (mm)	595	626	626	704

Table 2 - Dimensions of the free-standing pellet fire unit Hidro 17

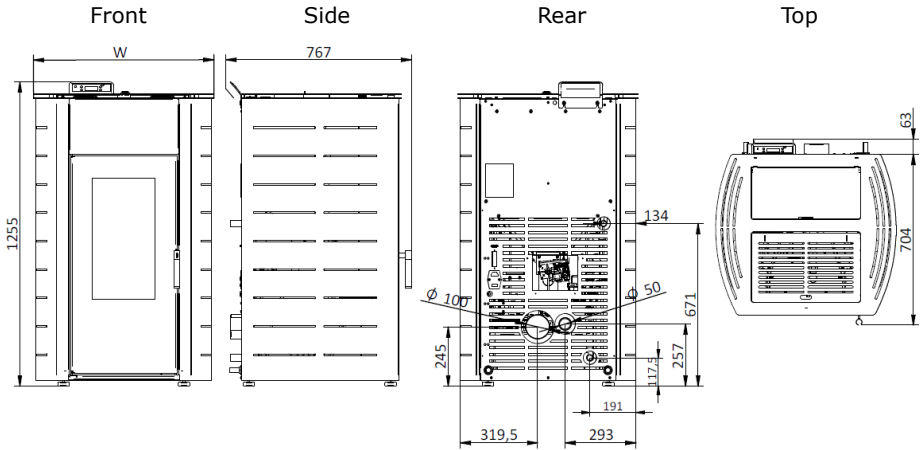


Figure 4 - Dimensions of the free-standing pellet fire unit Hidro 23 (K2)

Model	Douro	Fuji	Himalaia	K2
Dimension "W" (mm)	663	644	644	746

Table 3 - Dimensions of the free-standing pellet fire unit Hidro 23

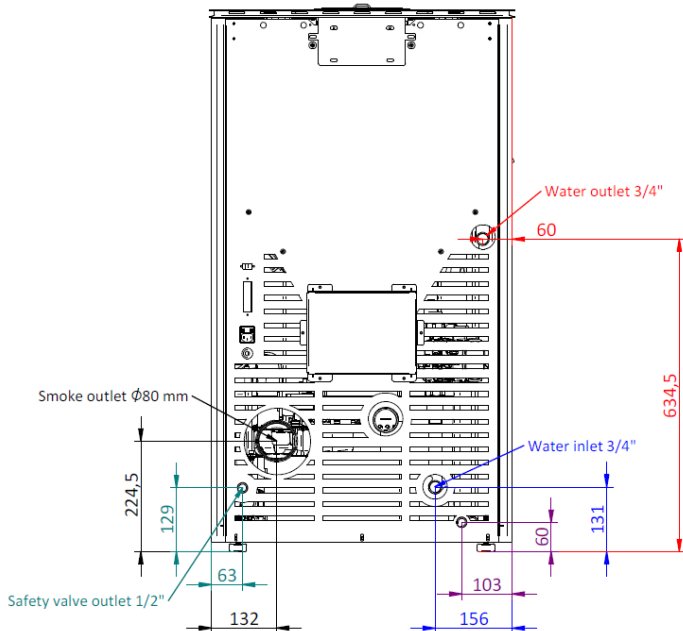


Figure 5 - Hydraulic connections of the free-standing pellet fire unit Hidro 12 (Fuji)

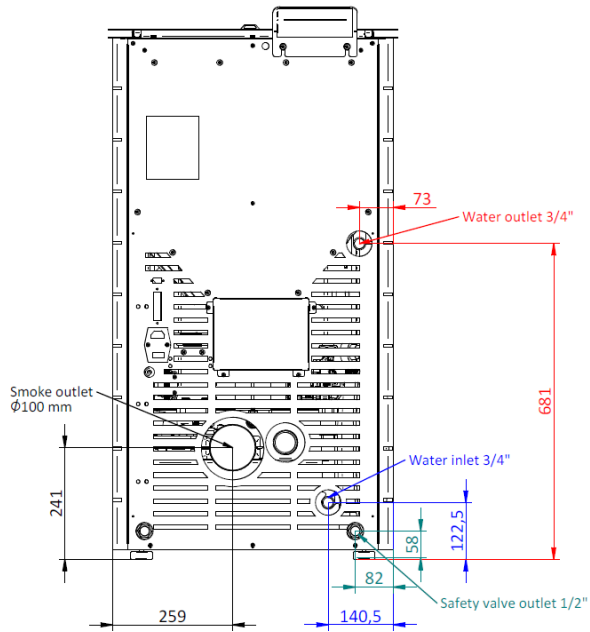


Figure 6 - Hydraulic connections of the free-standing pellet fire unit Hidro 17 (Himalaja)

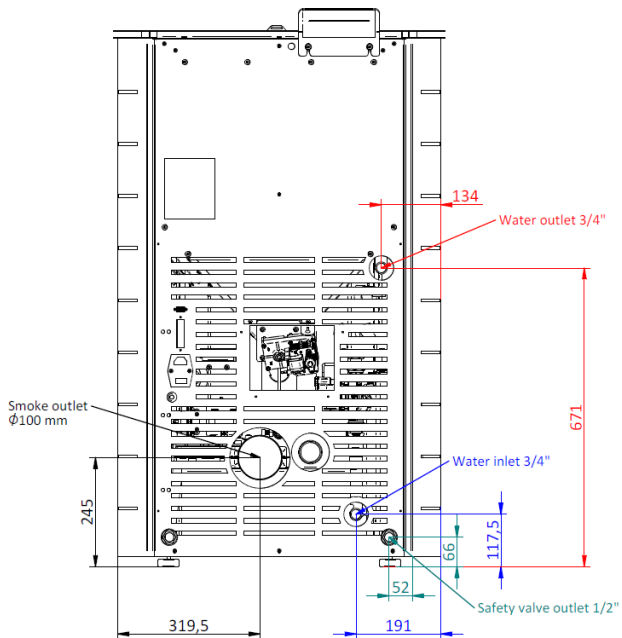


Figure 7 - Hydraulic connections of the free-standing pellet fire unit Hidro 23 (K2)

5. Installing the free-standing *pellet* fire

Before installing, please perform the following steps:

- Upon reception, check the product for completeness and to determine that it does not show any damage signs. Any damages or defects should be checked before the unit is installed;
- The unit is equipped with four adjustable height feet at the base which allow for a simple regulation when installed on a non-flat surface;



Figure 8 - Adjustable feet

- Remove the instruction manual from the package and hand it over to the client;
- Connect an 80mm wide (Hidro 12) or 100mm wide (Hidro 17 or Hidro 23) duct between the combustion gas output and the outgoing fume extraction duct of the building (e.g., chimney) – check diagrams point 5;
- If a tube is used for combustion air inlet from the outside, it shall be no longer than 60cm horizontally or present offsets (such as bends);
- Perform the hydraulic installation;
- Connect the 230VAC power cable to a grounded socket;
- The surface of the unit where the hot air outlet is located must be facing the area to be heated;
- The unit's remote control has a programmable thermostat. As an option, a conventional external programmer may be used (not included) to automatically setup the unit's operating periods. This should be connected through cable to the optional 230VAC programmer plug (not provided).

5.1. Installation requirements

The minimum distance between the free-standing pellet fire unit and particularly flammable surfaces is specified in Figure 9. The top of the unit must be at least 100cm separated from the ceiling, especially in rooms with ceilings consisting of flammable materials. The base supporting the unit cannot be made of combustible material (e.g., carpet), so make sure you use an adequate protection.

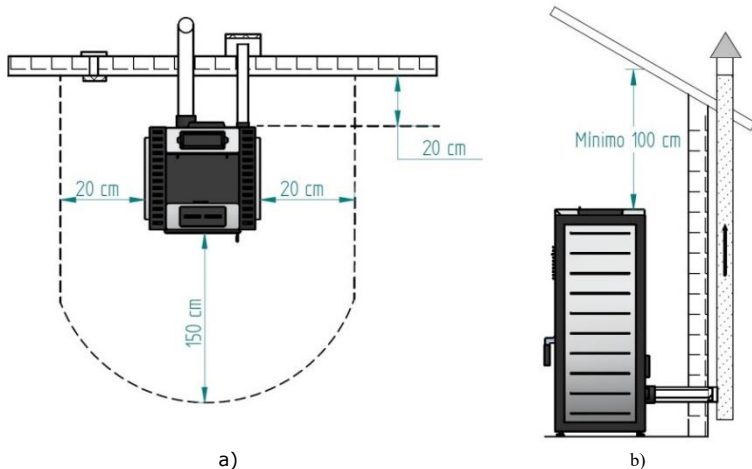



Figure 9 - Minimum distances from all surfaces: a) upper view of the unit's installation; b) side view of the unit's installation

WARNING!

Keep combustible and flammable materials at a safe distance.

5.2. Installation of ducts and fume extraction systems

- The exhaust pipe must have been designed for this purpose, in compliance to the location requirements and in accordance with any applicable regulations.
-  Important! An inspection-T with an airtight lid must be attached to the exhaust pipe of the unit to allow the regular inspection of the system or discharge of heavy dust and condensates.
- As indicated in Figure 9, the exhaust pipe must be assembled so as to allow cleaning and maintenance of the pipe by inserting inspection points.

- In the Hidro 17 model, if you want the flue to go up vertically behind the salamander, it is necessary to install a straight section of 25cm (Figure 10) before the cleaning "T". This ensures a minimum distance to the protection box of the auger loading motor.



Figure 10 - 25 cm stainless steel tube

- Under normal operating conditions, the combustion gas flow should create a draught of 12 Pa one meter above the chimney neck.
- The unit must not share the chimney with other equipment.
- Pipes outside the operating area must have double stainless-steel insulation and an internal diameter of 80 mm (Hidro 12) or 100 mm (Hidro 17 and Hidro 23).
- **The fume exhaust pipe may generate condensation, so we recommend that the appropriate systems for collecting condensates should be installed.**

5.3. Installation without a chimney

The installation of the free-standing pellet fire without a chimney should be performed as illustrated in Figure 11, equipped with an exhaust pipe (with a minimum diameter of 80 mm for the **Hidro 12** and 100 mm for the **Hidro 17** and **Hidro 23** model) directly outside and over the roof.

Double-walled stainless steel insulated pipes must be used and properly fastened to avoid condensation.

A T-tube must be installed at the base of the pipe to allow periodic inspections and annual maintenance, as illustrated in Figure 11.

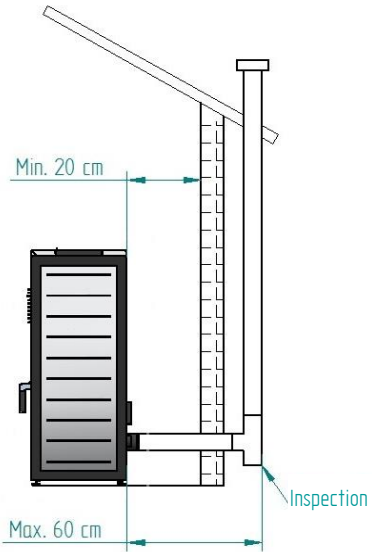
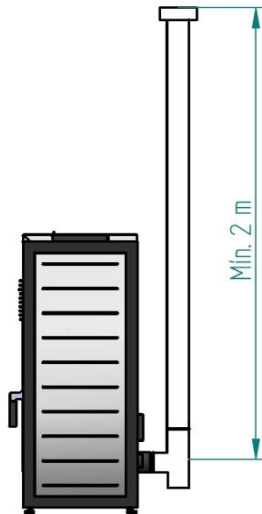
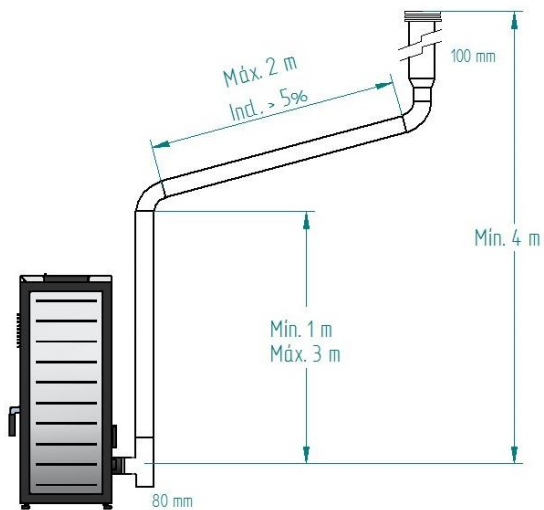


Figure 11 - Side view of the installation without a chimney, illustrating the inspection point

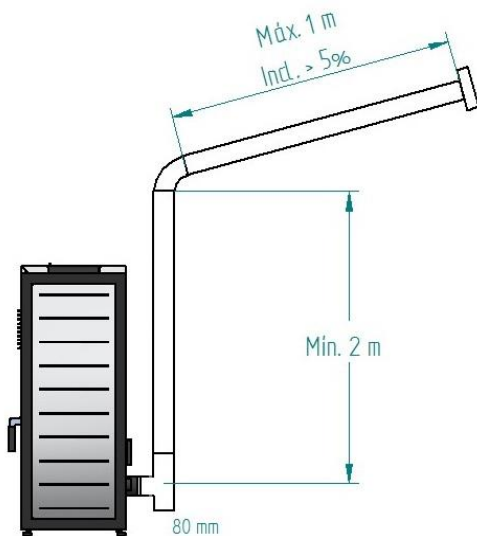
Figure 12 specifies the basic requirements for installing the chimney to the unit.



a)




b)



c)

Figure 12 - Examples of standard installations

 Failure to comply with these requirements may prevent the correct operation of the unit. Follow all the instructions presented on the diagrams.



The Hidro units operate with the combustion chamber in vacuum, so it is absolutely necessary to have a fume exhaust pipe to extract combustion gases properly.

Fume duct material: The tubing must consist of 0,5 mm thick rigid stainless steel, with fastening joints attaching the different sections and accessories.

Insulation: The fume ducts must be double-walled and insulated to make sure that fumes do not cool down going outwards, which would cause an inadequate circulation and condensation that may damage the unit.

Output "T-tube": Always attach to the output of the unit a "T-tube" with a regulator.

Windproof terminal: A windproof terminal must always be installed to avoid the backflow of fumes.

Draught in the chimney: The figures below show three standard diagrams, specifying adequate lengths and diameters. Any other type of installation must guarantee a draught of 12 Pa (0,12 mbars) measured when hot and at the maximum power.

Ventilation: To get the optimum operation of the unit it **is necessary that the installation location has an air inlet with a minimum section of 100 cm², preferably near the back panel of the unit.** The free-standing pellet fire unit has a circular pipe (Ø 50mm) that may be connected to the exterior of the house.

If the residence has an air exhaust system installed (e.g., kitchen extractor fan), a top ventilation section must be installed, suitable to accommodate the different air exhaust units' systems that exist in the house.

The installation of the unit on locations near kitchen exhaust fans or fume extractors may prevent the unit from operating properly.

5.4. Installation with a chimney

As shown in Figure 13, the unit is installed with an exhaust pipe ($\varnothing 80$ mm for the **Hidro 12**; $\varnothing 100$ mm for the **Hidro 17** and **Hidro 23**) directly on to the chimney. If the chimney is too large, an 80 mm-wide pipe should be installed at the fume outlet. A T-tube must be attached to the base of the pipe to allow for periodic inspection and annual maintenance, as illustrated in Figure 13.

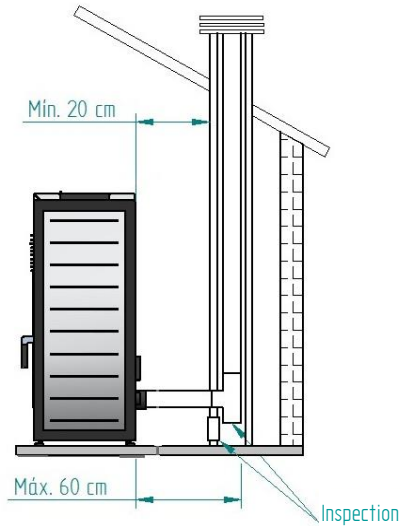


Figure 13 - Side view of the installation with a chimney, showing the inspection point

We do not recommend that you use the unit in rough weather conditions that may seriously impact the draught (particularly with very strong winds).

If you do not use the unit for a long time, check it to make sure that the flue pipes are clear before lighting the fire.

6. Hydraulic Installation

- The chapter 19 (installation diagrams) contains the optional connection diagrams for central heating installations, with or without water heating for household use;
- The free-standing pellet fire unit is equipped with a circulating pump, an expansion vessel (6 litre volume (in the Hidro 12 and 17 model) or 10 litre volume (in the Hidro 23 model) and pre-charge of 1 bar) and a 3-bar safety valve;
- Operating pressure is between 0,8 and 1,2 bar (for Hidro 12) and 1 and 1,5 bar (for Hidro 17 and Hidro 23);
- To empty the unit, attach a "T-tube" with a tap to the outlet (connected to the household sewage); the safety valve (3 bar) outlet must also be connected to the household sewage;
- The heating fluid must consist of water with an anti-rust, non-toxic product added in the quantity recommended by the manufacturer. If the unit installation or the fluid pipes are installed are likely to freeze, the installation engineer must add to the circulating fluid the amount of antifreeze product recommended by the manufacturer, to avoid freezing at the estimated minimum temperature.

6.1. Operating mode for radiator/buffer tank



IMPORTANT! The boiler is programmed to work directly for radiators, in case you want to install the boiler with a buffer or AQS tank, we recommend changing the temperature "OFF" of the circulation pump by placing the same temperature as the deposit or 1 °C higher than this temperature, should disable the "hYDRO Menu" modes "Modulating Pump" and "hydro independent" and switch the mode display "Auto" to "Manual" mode and select the power 5 (Fire 5).

For these changes is necessary to access the "Installer Menu" on the display, please request a password manufacture.

7. Fuel

The Free-Standing Pellet Fire operates exclusively with pellets. No other fuel sources are allowed to be used.

Only use *pellets* certified by standard EN 14961-2 grade A1 with a **diameter of 6mm** and a length of **10-30mm**.

The pellets may have a maximum humidity of 8% their weight. To guarantee a good combustion, the pellets must maintain these characteristics so it is recommended that they should be stored in a dry place.

The use of different pellets will reduce the efficiency of the unit and cause deficient combustion.

Only certified pellets should be used and a sample must be tested before buying large bulks.

The physicochemical properties of the pellets (namely, calibre, friction, density and chemical composition) may vary within specific tolerances and across manufacturers. Please note that this may cause changes to the feeding process and, consequently, the need for different doses (more or less pellet quantity).

The unit allows for an adjustment of +15%/-33% the pellet dosage at the start-up phase and at each power level (please see section 9.2.7 of this manual).



WARNING!

This unit may NOT be used as an incinerator.

8. Using the Free-Standing Pellet Fire

! The pellet stoves must be serviced as described in point 3.6, page 110 (Warranty). In order to adjust the operating parameters of the stove (pellet stove), the dosing must be adjusted as described in section 7 of this manual. The pellet dose must be adjusted according to the gas temperature and pellet consumption of the appliance at the rated power described in Table 1, page 5, in order to ensure that the appliance delivers the correct power.

Recommendations

Before starting up the unit, please check the following:

- Ensure the unit is properly connected to the power mains using the 230V AC power cable.



Figure 14 - Electric power plug

Check if the pellet reservoir is supplied with pellets. Inside the pellet reservoir is a safety grid to prevent users from reaching the worm screw.

- Ensure that before each ignition the burner is clear.

! **The unit's combustion chamber and panel door are made of iron plate painted with high temperature resistant paint which releases fumes during the initial burn due to the paint's curing process. Avoid touching the unit during its first burn to prevent leaving permanent marks on the paint. The paint goes through a more plastic phase during the curing process. The curing of the paint occurs at approximately 300°C for 30 minutes.**

Please make sure the room where the unit is installed has adequate air circulation; otherwise, the unit will not work properly. For this reason, it is important to check if there are any other air-consuming heating appliances present in the room (e.g., gas units, braziers, extractors, etc.); these should not be used simultaneously with the unit.

This Free-Standing Pellet Fire unit has a probe for measuring the room temperature. This probe is attached to the grid at the rear panel (Figure 15). For a good reading of the room temperature, avoid the contact between the end of the probe and the unit surfaces. You may also attach the probe to the wall beside the unit.



Figure 15 - Room temperature probe

9. Remote Control

9.1. Remote control and display

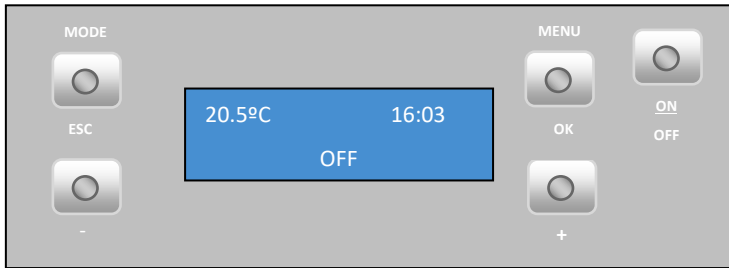
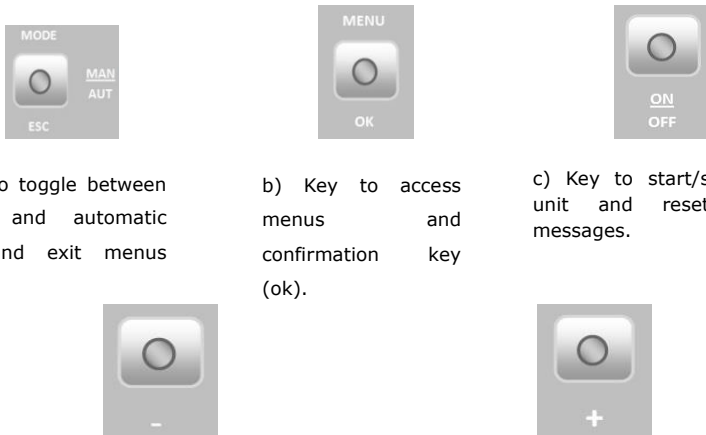


Figure 16 - Room temperature probe



a) Key to toggle between manual and automatic mode and exit menus (esc).

b) Key to access menus and confirmation key (ok).

c) Key to start/stop the unit and reset error messages.

d) Key to scroll the menus to the left, to increase and reduce the fan flow and increase or reduce the set-point temperature.

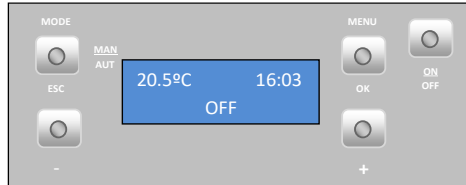
e) Key to scroll menus to the right and increasing and to reduce the unit's power.

Figure 17 - Remote control keys

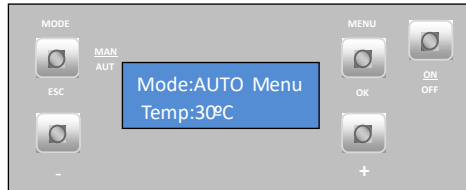
9.1. Display information summary

9.1.1. Menu

Menu indicating that the unit power is "off", the room temperature in °C and Time.



Selecting the operation mode: to select the operation mode, press the "mode" key to select "Manu" for manual mode or "Auto" for automatic mode.



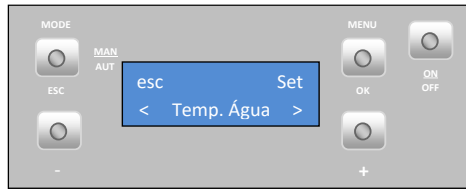
"Auto" mode: in this mode, the unit shall be turned on at maximum power until reaching a temperature of 1°C above the temperature selected (set point temperature). Upon reaching the set temperature, the unit changes to minimum operating power.

The set-point temperature can be set between 5 and 40°C by pressing the "-" and "+" keys.

"Manu" mode: in this mode, the unit will run at the speed selected with the "-" key, which may vary between 1 (minimum operating speed) and 5 (maximum operating speed).

9.1.2. Water temperature

Press the Menu key twice to set the water temperature, "Temp. Água" (Water Temp.) appears on the display. Press Set to see the "T. Aquecimento" (Heating T.) menu.



- Heating temperature

To set the desired **Heating Temperature** press "set". The display starts to flash. Press the "+" or "-" key to select the desired temperature and then "ok" to confirm. Press the "+" key to go to the "Temperatura de sanitários" (Bathroom Temperature) menu.



Note: in the equipment the water temperature can be regulated by the user (water set-point temperature) between 50 and 80°C.

- Bathroom temperature (**this mode is disabled**)

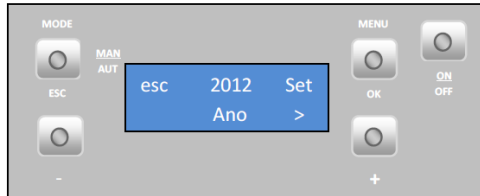
9.1.3. Date

To set the **Date**: press the Menu key twice and "Data" (Date) appears on the display. Press "set" to see the menu.



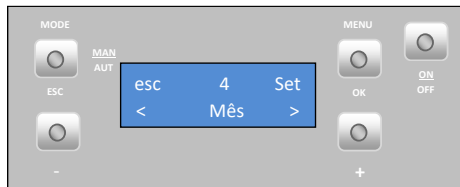
- Year

To set the **Year** press "set". The display starts to flash. Press the "+" or "-" key to select the desired year and then "ok" to confirm. To move to the next menu, press the "+" key and the Month menu appears.



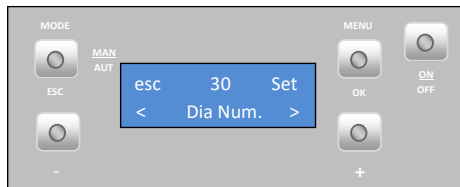
- Month

To set the **Month** press "set". The display starts to flash. Press the "+" or "-" key to select the desired month and then "ok" to confirm. Press the "+" key to go to the "Dia do Mês" (Day of the month) menu.



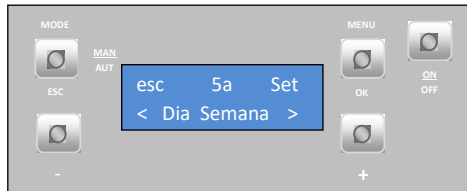
- Day of the month

To set the **Day of the month** press "set". The display starts to flash. Press the "+" or "-" key to select the desired day and then "ok" to confirm. Press the "+" key to go to the "Dia" (Day) menu.



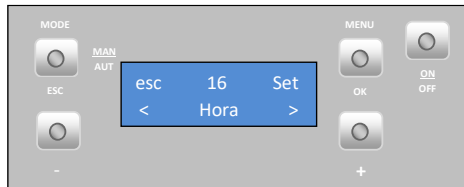
- Day

To set the **Day of the week** press "set". The display starts to flash. Press the "+" or "-" key to select the desired day and then "ok" to confirm. Press the "+" key to go to the "Hora" (Time) menu.



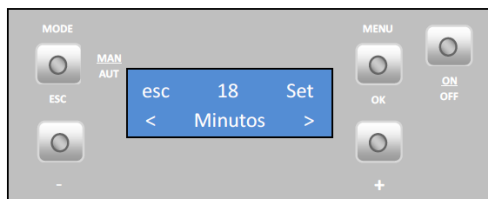
- Time

To set the **time** press "set". The display starts to flash. Press the "+" or "-" key to select the desired time and then "ok" to confirm. Press the "+" key to go to the "Minutos" (Minutes) menu.



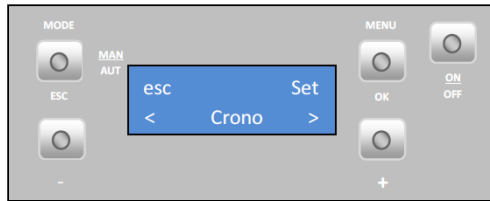
- Minutes

To set the **Minutes** press "set". The display starts to flash. Press the "+" or "-" key to select the desired minutes and then "ok" to confirm. Press the "esc" key to exit. Press the "+" key to go to the next menu and the Crono (Timer) menu appears.



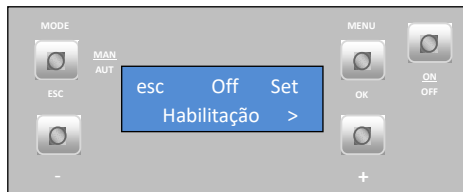
9.1.4. Timer

The unit is equipped with a timer that allows the unit to be turned on or off at a specified time.



- Activation

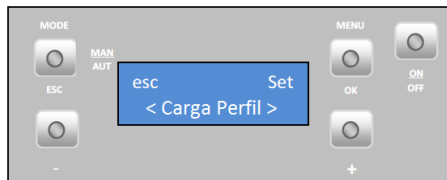
To **activate the timer** press "set". The "Habilitação" (Activation) menu appears. The timer may only be activated after setting the configurations, as shown in the following paragraph.



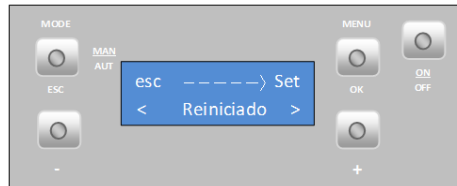
The programs can be defined in two different ways, either by the "profile load" menu or by the daily programmer P1 to P6 (**only one option can be active, they do not work simultaneously**).

Press the "+" key to scroll to the "Carga Perfil" (Profile Load) menu.

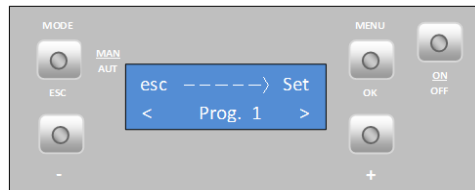
There are 10 weekly programmes available on the Timer (see item 24 in the annexes). The selected programme runs from Monday to Friday and from Saturday to Sunday. Press "set"; the display starts to flash. Press the "+" or "-" key to select the desired programme and then press "ok" to confirm. Press the "+" key to go to menu "Reiniciado" (Reset).



This menu allows you to delete any programme settings. To do this, press "set" and the message "Confirm?" appears. Press "ok" again to confirm the order for deleting the programs, or "esc" to exit and then press the "+" key to proceed to the daily programmer.

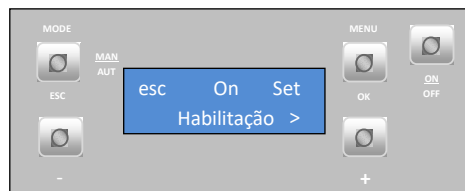


The unit's **programmer** lets you choose from 6 different programmes for each day of the week.

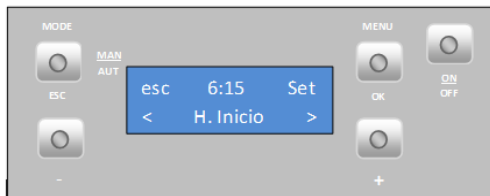


To set up **programmes "P1" to "P6"**, select the desired programme using the "-" and "+" keys, and press "set" to select. The "Habilitação" (Activation) menu appears (**can only be enabled after time scheduling**).

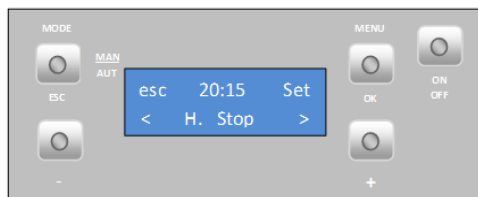
Press the "+" key to go to the "H. Inicio" (Star Time) menu.



To set the **starting time** for Programme P1, press "set". The display starts to flash. Press the "+" or "-" key to select the time and then press "ok" to confirm. Press the "+" key to go to the "P1 A. Stop" menu.

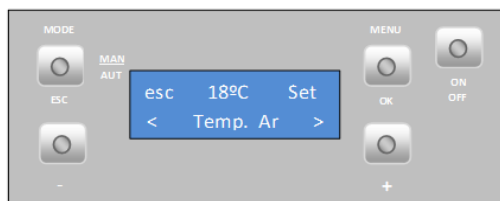


To set the **stopping time** for Programme P1, press "set". The display starts to flash. Press the "+" or "-" key to select the time and then press "ok" to confirm. Press the "+" key to go to the "P1 Temp." (P1 Air Temp.) menu.

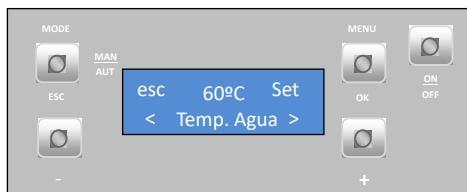


Important: Each program can **only** be configured within the **same** day.

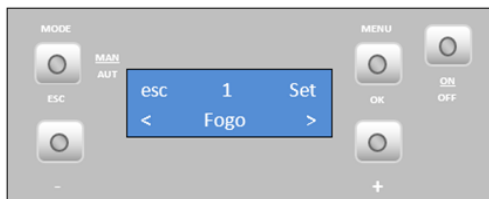
To set the **set point temperature** for Programme P1, press "Set". The display starts to flash. Press the "+" or "-" key to select the desired temperature, followed by "Ok" to confirm. Press the "+" key to go to the "P1 Temp. Água" (P1 Water Temp.) menu.



To select the **set point water temperature** in program P1, press "set" and start flashing, press "+" or "-" to select the desired temperature, press "ok" to confirm value. Press the "+" key to move to the "Fire" menu.



To set the **operating power level** (1 to 5) of Programme P1, press "Set". The display starts to flash. Press the "+" or "-" key to select the desired power level (1 to 5), and then "Ok" to confirm. Press the "+" key to go to the "P1 Dia" (P1 Day) menu.



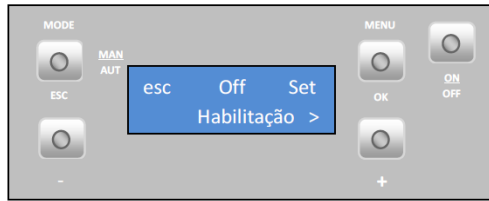
To select the **days of the week** that you want P1 Programme to run, press "set" and then select the day of the week using the "-" and "+" keys. Press "set". The display starts to flash. Select "On" or "Off" using the "-" and "+" keys. Press "ok" to confirm the selection. Press the "esc" key to go to the "P1 Dia" (P1 Day) menu. Press "esc" twice and then "+" to access the "Configurações" (Configuration) menu.



Press "set" again and when flashing, press the "+" or "-" keys to select "On" or "Off". Press "ok" to confirm your choice.

Repeat the above steps for programmes P2 to P6.

To activate Timer mode, press "esc" once and then "-" until you find the "Activation" menu, press the "set" key and it starts flashing, press the "+" or "-" key to select "On" or "Off", press "ok" to confirm your choice. Press the "esc" key once and then press the "+" key once to move to the "Sleep" menu.

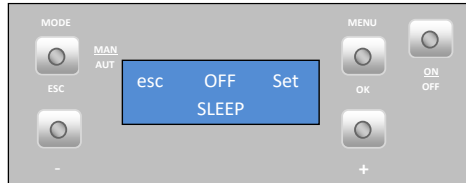


Note:

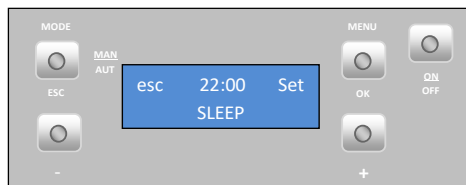
- Once the programmes are set, remember to enable them on the "Habilitações" (Activation) menu.
- There can only be one enabled profile in the Timer, either weekly or daily (they do not operate simultaneously).
- When the Timer is enabled, you can check the following message in the display: "chrono prog".

9.1.5. Sleep (this menu is displayed only while the unit is operating)

The "Sleep" menu allows you to setup the time you want the unit to turn off.

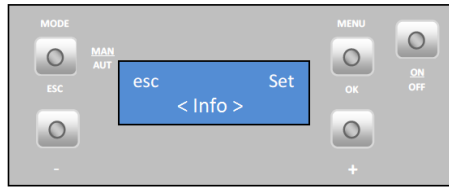


Press "set". The display starts to flash. Select the desired time using the "-" and "+" keys. After choosing the time, press "ok" to confirm. Press "esc" to return to the menu and "+" to go to the info menu.



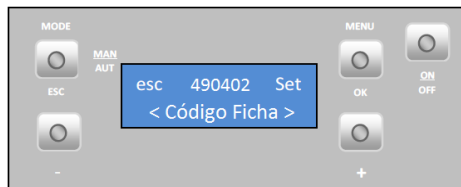
9.1.6. Info

This menu contains information on the Free-Standing Fire unit.

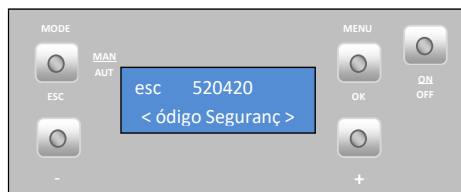


Press "set"; the "Código de Ficha" (File Code) menu appears.

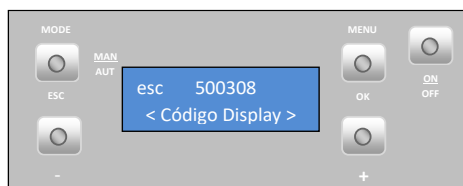
Software code / Motherboard firmware. Press the "+" key to scroll to the "Código de Segurança" (Security Code) menu.



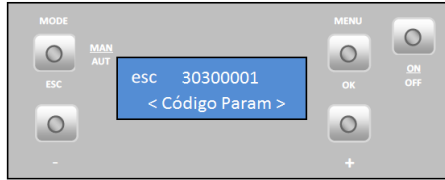
Software code / Security firmware. Press the "+" key to scroll to the "Código Display" (Display Code) menu.



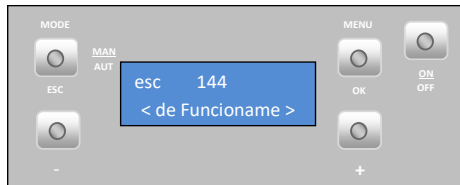
Software code / Display firmware. Press the "+" key to scroll to the "Código de Parâmetros" (Parameter Code) menu.



Parameter code. Press the "+" key to scroll to the "Horas de Trabalho" (Operation hours) menu.

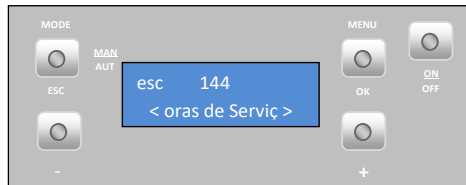


This menu shows the unit's current operating hours.



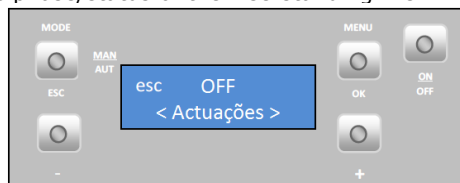
This menu shows the number of operating hours the unit has registered since its last servicing.

The number of hours at which the next servicing should take place.

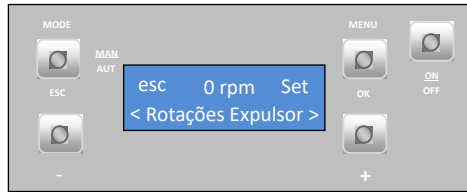


Very Important: When the machine is close to service hours it is recommended to call an accredited technician to perform its maintenance.

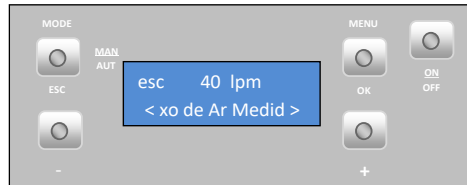
This menu shows the phase/status of the free-standing fire.



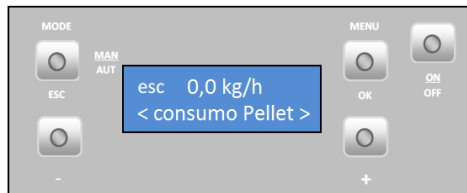
Fume extractor operating speed (rotation per minute).



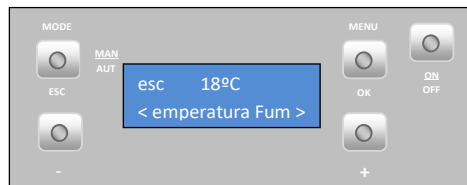
Air flow measured by air sensor.



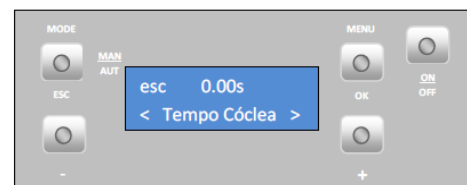
Theoretical pellet consumption.



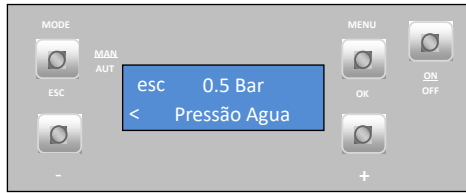
Fume temperature.



Worm drive rotation "On" time.



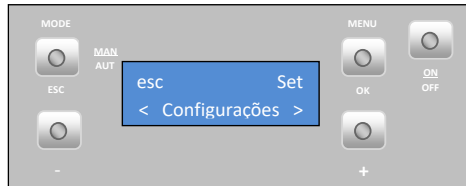
Hydraulic circuit pressure.



Press the "esc" key once and then "+" to go to the "settings" menu.

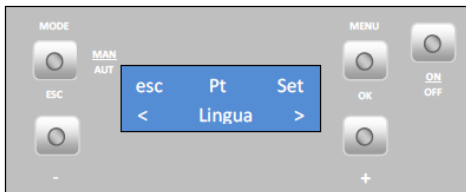
9.1.7. Settings Menu

To modify the unit's **settings**, press "Set". The "Língua" ("Language") menu should then appear, allowing the user to choose a set language.



- Language

To select the **language**, press "set". Using the "+" or "-" keys, select the language (**Pt** – Portuguese; **Nl** – Dutch; **Gr** – Greek; **Tr** – Turkish; **It** – Italian; **En** – English; **Fr** – French; **Es** – Spanish; **De** – German). Press "ok" to confirm. Press the "+" key scroll goes to the "Eco" menu.



- Eco mode

When the "ECO" mode is enabled at the same time as the Thermostat feature, the unit will operate at maximum power until the thermostat opens contact (NO). The unit then will operate at minimum power for a present period of time (Shutdown delay time:

factory setting: 20 minutes). Once the present time is elapsed, the unit shuts down. At the start of the Shutdown phase, another timer for a different present period of time is triggered (Start-up delay time: factory setting: 20 minutes), that will make the unit enter the activation phase, when the thermostat closes contact (NC)

Start-up delay time (Delay time on): The delay time that elapses between the moment the thermostat closes (NC) until the unit is activated.

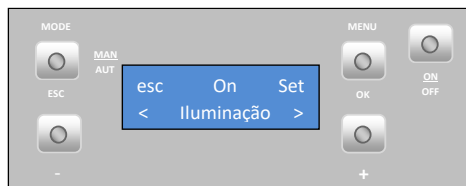
Shutdown delay time (Delay time Off): The delay time that elapses between the moment the thermostat opens (OC) until the unit starts to shut down.

Note: When using the feature for the first time, you must press the on/Off button in the display. To enable the eco mode, press "set". The display starts to flash. To activate the eco mode, press "set". The display starts to flash. Select "On" or "Off" using the "-" and "+" keys. Press "set" to confirm the selection. Press "esc" to return to the previous menu and then press "+" to go to the "Iluminação" (Lighting) menu.



- Lighting

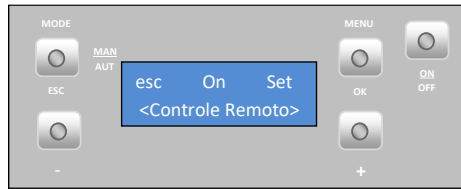
To select **lit screen**, press "set". The display starts to flash. Press the "+" or "-" key to select the time for the screen to light up, or select "On" to keep the light permanently on. Press "ok" to confirm. Press the "+" key to go to the "Controlo remote" (Remote control) menu.



- Remote control (**not applicable**)

This feature enables and disables the remote control, when the user wants to operate the unit's thermostat remotely. Press "Set" and use the "+" and "-" keys to select the

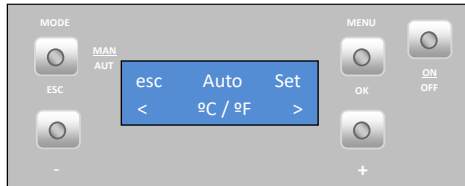
“On” or “Off” mode. Press “Ok” to confirm. Press the “+” key to go to the “Unidade de temperatura” (Temperature units) menu.



Note: Some TV remote controls share the same frequency as the unit’s remote control, possibly influencing the unit’s operation. If this is the case, it is recommended to disable the remote-control feature.

- Temperature unit (°C / °F)

To select **°C / °F**, press “set”. The display starts to flash. Press the “+” or “-” key to select “°C”, “°F” or “Auto”, and then “ok” to confirm. Press the “+” key to go to the “Combustion recipe” menu.



- Combustion recipe

Press “set” to display the “Combustão receita” (Combustion recipe) menu.



- Pellet

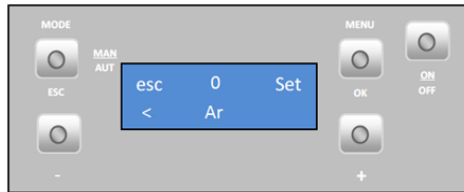
This feature allows the user to increase or decrease up to 25% the **pellet quantity during the start-up and power process**. Press “set”. The display starts to flash. Press “+” or “-” to increase or decrease (between -10 to +10), as required. Each unit

must be multiplied by 2,5 to obtain the correct percentage. Press "ok" to confirm. Press the "+" key to go to the "Ar" (Air) menu.



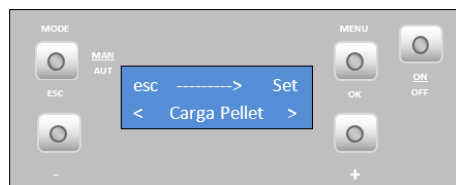
- Air

This feature allows the user to increase decrease up to 25% the **rotation speed of the fume extractor during the start-up and power process**. Press "set". The display starts to flash. Press the "+" or "-" key to increase or decrease (from -10 to +10), as required. Each unit must be multiplied by 2,5 to obtain the correct percentage. Press "ok" to confirm. Press "esc" to return to the "Receita de pellets" (Pellet recipe) menu and then press "+" to go to the "Carga pellet" (Pellet loading) menu.



- Pellet loading (this function only appears when the machine is switched Off)

This feature allows you to enable the **worm drive** to fill the channel when it is empty to keep the unit running. Press "set"; the "ok" option appears. Press "ok" to activate the drive; the message "habilitada" (enabled) is displayed. Press "esc" to stop. Press the "+" key to go to the "Limpeza" (Cleaning) menu.



- Cleaning (this function only appears with the machine in Off)

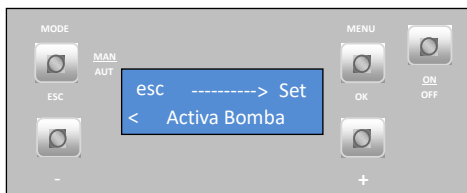
This feature allows you to **clean** the burning basket manually. Press "set"; the "ok" option appears. Press "ok" to start the cleaning procedure; the "Habilitada" (Enabled) message is displayed. To stop, press "ok". Press the "+" key to go to the "Técnico" (Technical) menu.

Press the "esc" key and then "+" once to switch to the "Active Pump" menu.



- Active Pump (this function only appears with the machine in Off)

This function allows the **water pump** to be driven manually. Press "set" and the message "enabled" appears.



Press the "esc" key once and then "+" to go to the "Technical Menu" menu.

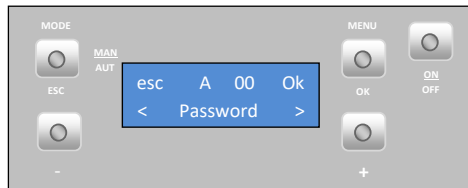
The technical menu is not available to the end user.

9.1.8. Technical Menu

This feature allows the user to adjust the unit's different variables. Pressing "set" displays the "password" menu to enter the technical menu.



Press "Ok"; the letter "A" starts to flash. Using the "+" and "-" keys, select the desired letter. Press "Ok" to confirm; the numbers "00" start to flash. Using the "+" and "-" keys, select the desired number. Confirm by pressing "OK" to go to the "Configuração" ("Settings") menu.



Note: The password is only provided to authorised technicians.

10. Alarm/ Failure / Recommendation List

Alarm	Code		Troubleshooting
Ignition failure	A01	Maximum time 900 sec	<ul style="list-style-type: none"> - The worm drive channel is empty - restart the unit - Resistance burnt - replace resistance - The burning basket has been incorrectly installed - Worm locked - unlock - Smoke temperature did not exceed the value set at captivation
No flame or lack of pellets	A02	Temperature under: 104°F (40°C)	<ul style="list-style-type: none"> - Pellet reservoir is empty
Excess heat in the pellet drum	A03	110 °C	<ul style="list-style-type: none"> - The fan is not working - call for assistance - Faulty thermostat - call for assistance - Machine with faulty ventilation
Excess fume temperature	A04	Over 446°F (260°C)	<ul style="list-style-type: none"> - The fan is not working or is working at a low power level - increase the level to the maximum (if the problem persists, call for assistance) - Insufficient extraction - Excess pellets - Faulty smoke probe
Pressure switch alarm	A05	The door is open, lack of draught or extractor fault for 180 sec	<ul style="list-style-type: none"> - Close the door and clear the error message on the faulty pressure regulator - Obstruction of the exhaust pipe or faulty extractor
Air mass probe	A06	40 Ipm delta for 3600 sec	<ul style="list-style-type: none"> - Pipes with insufficient extraction or obstructed pipes
The door is open	A07	Door open for 120 seconds	<ul style="list-style-type: none"> - Close the door - clear the error message - Faulty air mass sensor
Fume extractor is faulty	A08	Connection failure	<ul style="list-style-type: none"> - Check connection - Check that the fan is not blocked
Fume probe failure	A09	Connection failure	<ul style="list-style-type: none"> - Check connection
Pellet resistance error	A10	Connection failure	<ul style="list-style-type: none"> - Check connection - Faulty resistance
Worm drive error	A11	Connection failure	<ul style="list-style-type: none"> - Check connection - Faulty auger motor
Pellet level alarm	A15		<ul style="list-style-type: none"> - Check connection
Water pressure outside operating range	A16		<ul style="list-style-type: none"> - Check connection - Check pressure in the hydraulic circuit - Adjust pressure (1 bar) in the hydraulic circuit (working range 0,5 to 2,8 bar)
Excess temperature water	A18		<ul style="list-style-type: none"> - Check connection - Check if the pump works - Purging hydraulic circuit - Check that the heat exchangers are open

Table 4 - List of alarms



Important note: all alarms cause the machine to shut down. The alarm must be reset and restarted. To reset the unit, press the "On/Off" button for 10 seconds until the alarm sounds.

- Failures

Failures
Maintenance "service"
Air mass sensor fault
Low pellet level
Door open
Air temperature sensor faulty
Failure of the water temperature sensor
Water pressure sensor faulty
Water pressure near the extremes of the operating range

Table 5 - List of failures



Important notice: A "**service**" warning on the display (maintenance due) indicates that the unit has exceeded 2100 operating hours. In this case, the client must perform the unit's maintenance procedure (following the instruction on the Technical Manual). Once this procedure is completed the hour meter may be reset, to clear the warning message. This message does not impact the normal operation of the unit. It is simply a warning.



Important notice: The errors can be reset only when the error information is flashing on the display. To reset the error, press the "Mode" button once while displaying the error.



WARNING!

In case of an emergency, turn off the unit by following the normal shutdown procedure.

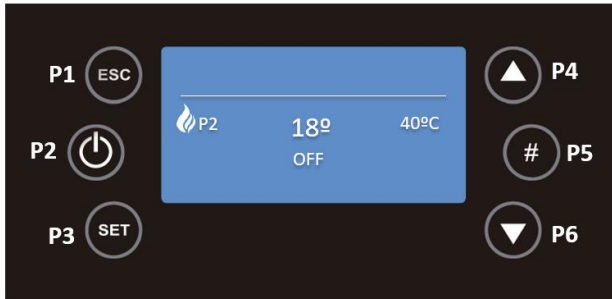


WARNING!

THE UNIT BECOMES HOT DURING OPERATION SO CARE MUST BE TAKEN ESPECIALLY WHEN HANDLING THE DOOR GLASS AND DOOR HANDLE.

11. Control Columbus

Solzaima stoves may be equipped with Columbus electronics, the Columbus display is as shown below. To confirm if your equipment is equipped with these electronics, please check the serial number of the equipment and refer to Table 6.



Columbus Electronic	Serial No. of equipment
Hidro 12	≥ 01-21-00193
Hidro 17	≥ 01-21-00243
Hidro 23	≥ 01-21-00291

Table 6 - Serial No. with Columbus electronic







11.1. Display

When connecting the equipment, the display indicates the "OFF" status of the stove, and can also indicate the chrono activation, system errors, selected combustion power, selected ventilation power, current room temperature and selected room temperature set-point.

In the Home Page by pressing the key:

- "P1" it's possible to exit the menu/submenu;
- "P2" it's possible to switch on the equipment, or, switch off the equipment. The same button allows the errors reset, by pressing 3 seconds continuously, it also allows the activation of Chrono in the corresponding submenu;
- "P3" it's possible to access the user menu 1, by pressing 3 seconds on the same button we can access the user menu 2 and it also allows saving changes;

- "P4" it's possible to enter the Combustion Power menu;
- "P5" it's possible to enter the Information menu and also activate a Chrono time slot;
- "P6" it is possible to enter the Room Thermostat menu;
- "P3" + "P5" for 3 seconds it is possible to access the secondary information menu present in the service menu where it is possible to check a set of variables.

Led	Meaning
D  W  WE 	<ul style="list-style-type: none"> • When this Led is active it means that the Chrono is in Daily Mode ON, Weekly Mode ON or Weekend Mode ON.
	<ul style="list-style-type: none"> • When this LED is active, it means that the required room temperature has been reached.
	<ul style="list-style-type: none"> • Summer
	<ul style="list-style-type: none"> • Winter



THE STOVE MUST ALWAYS BE DEACTIVATED IN THE SAME WAY IT WAS ACTIVATED. THE EQUIPMENT MUST NEVER BE UNPLUGGED DURING THE ACTIVATION PROCESS.

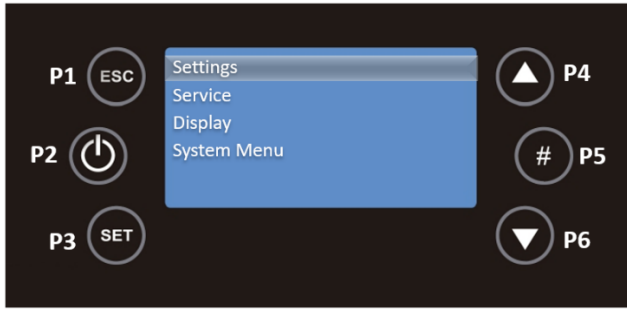
11.2. Settings Menu

11.2.1. Language

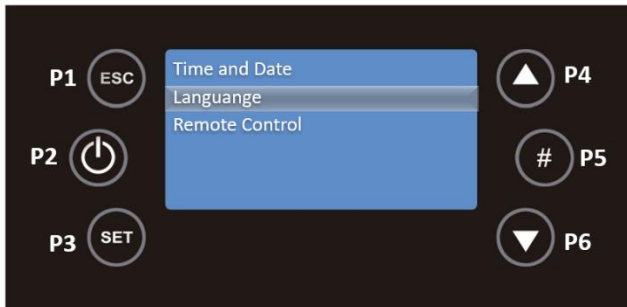
By pressing the P3 key for 3 seconds, you will display the Settings, Service, Display and System menus.

SYSTEM MENU IS AN EXCLUSIVE ACCESS MENU FOR THE TECHNICAL SERVICE AND REQUIRES A PASSWORD.

With the P4 and P6 keys you must select the required menu and then press P3 to validate your choice, in this case the Settings menu.



Select the Language submenu with the P6 key and to validate the entry in this submenu the P3 key.



Within this submenu, with P4 and P6 select the required language and press P3 again to confirm.

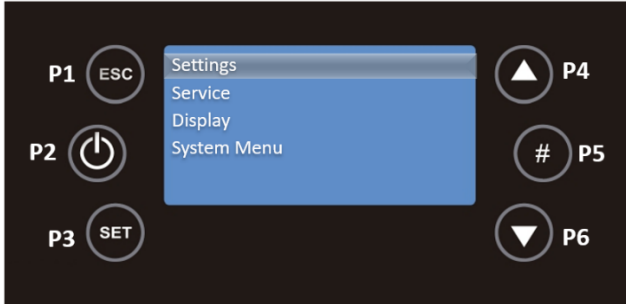


To exit the Language menu, press the P1 key.

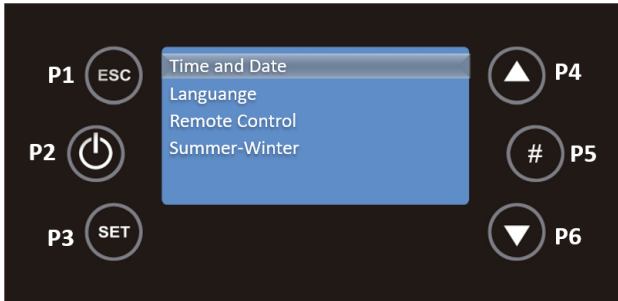
11.2.2. Time and Date

- **Time**

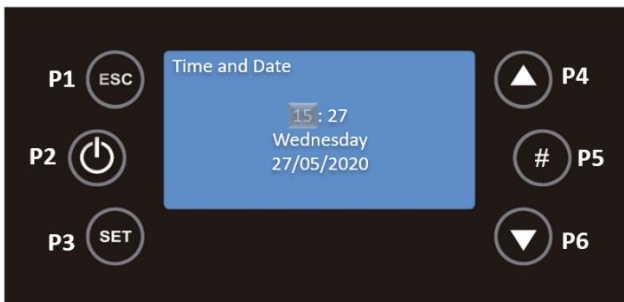
From the main screen, by pressing for 3 seconds the P3 key, you can access the Settings menu, by pressing again on P3 to enter this menu.



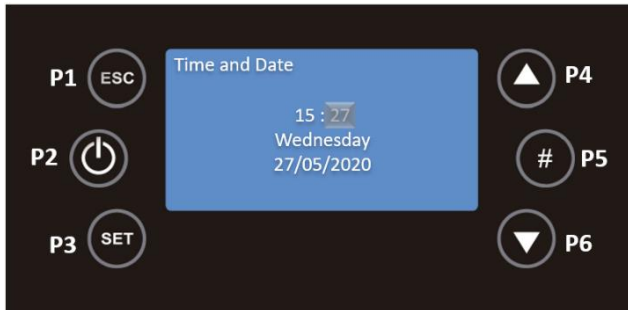
Use the P3 key to select Date and Time.



In the Date and Time menu, select Time, with the P4 and P6 keys, and press the P3 key, the time will appear in editable mode, flashing, with P4 and P6 select the correct time and press P3 to validate.

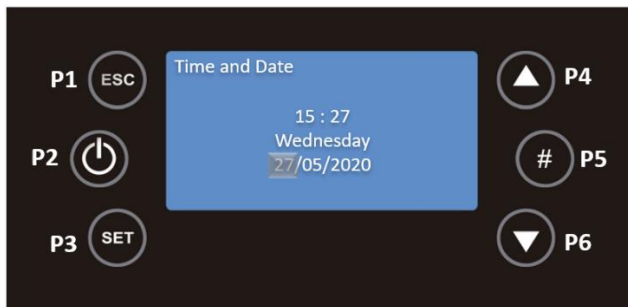


The same must be done for Minutes, with P6 select Minutes and press P3, the minutes will appear in editable mode, flashing, with P4 and P6 select the correct minutes and press P3 to validate.



- **Date**

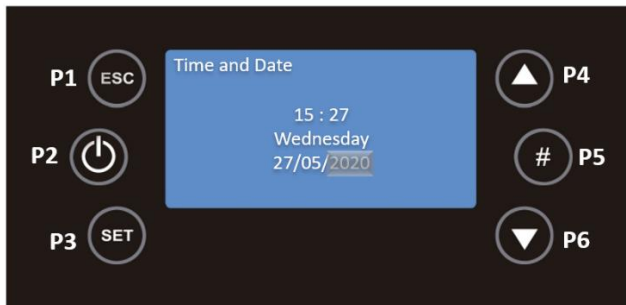
In the same menu, select Day with the P4 and P6 keys and press P3, the day will appear in editable mode, flashing, with P4 and P6 select the correct day and press P3 to validate.



To edit the Month, you must use the P4 and P6 keys to select this information and then P3, the month will appear in editable mode, with P4 and P6 select the desired month and then press P3 again to validate.



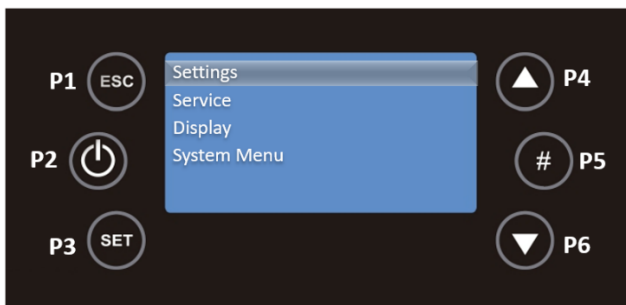
The Year follows the same procedure, press the P4 and P6 keys to move to the Year, use the P3 key to edit this field, the year will appear in editable mode. With P4 and P6 select the desired year and press P3 to validate.



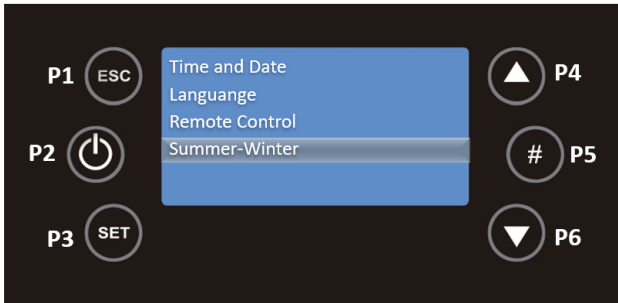
THE DAY OF THE WEEK (SUNDAY TO SATURDAY) CHANGES ACCORDING TO THE DAY OF THE WEEK SELECTED.

11.2.3. Summer-Winter (not applicable)

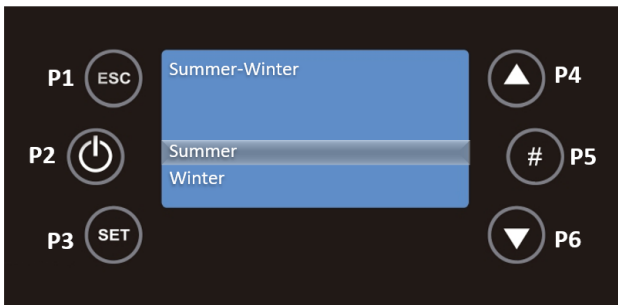
From the main screen, by pressing for 3 seconds the P3 key, you can access the Settings menu, by pressing again on P3 to enter this menu.



Use the P6 key to select the Summer-Winter submenu and confirm the entry in this submenu with the P3 key.

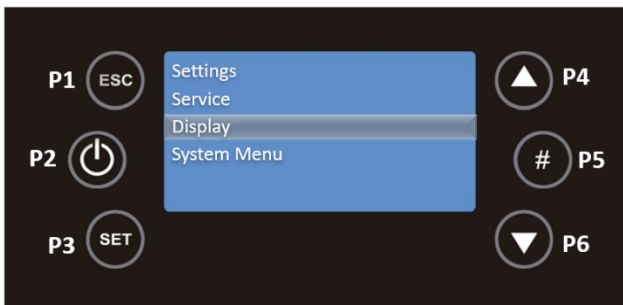


By pressing the P4 and P6 buttons, you can choose between summer or winter mode, this menu allows you to modify the functioning of the control unit according to the season. Use the P3 key to validate the choice.



11.3. Display Menu

By pressing the P3 key for 3 seconds, you will see the Settings, Service, Display and System menus. Use the P4 and P6 keys to select the required menu and then press P3 to confirm the choice, in this case the Display menu.



In this menu there are the functions Contrast, Min Brightness, Screen Saver and Firmware Codes.



11.3.1. Contrast

Press the P3 key to validate the choice of this function, with the P4 and P6 keys you can set the contrast between 0 and 30 for your screen. To return to the Display menu, press P1.



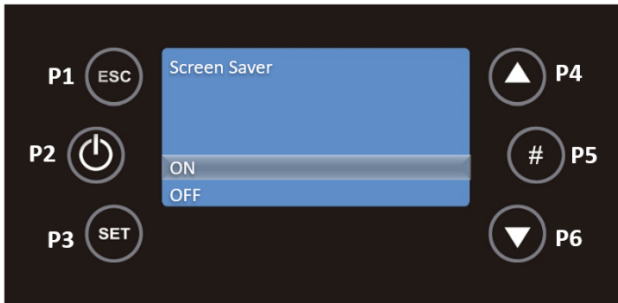
11.3.2. Min Brightness

In the Display menu with P4 and P6 select the Min Brightness function by pressing on the P3 key. With the P4 and P6 keys you can set the brightness between 0 and 20 for your display. To return to the Display menu, press P1.



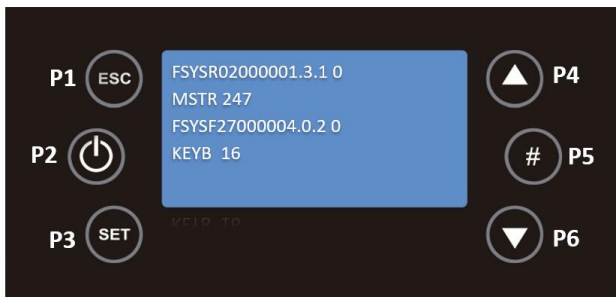
11.3.3. Screen Saver

In the Display menu with P4 and P6 select the Screen Saver function by pressing on the P3 key. In this function you can activate or deactivate the screen lock. To return to the Display menu, press P1.



11.3.4. Firmware Codes

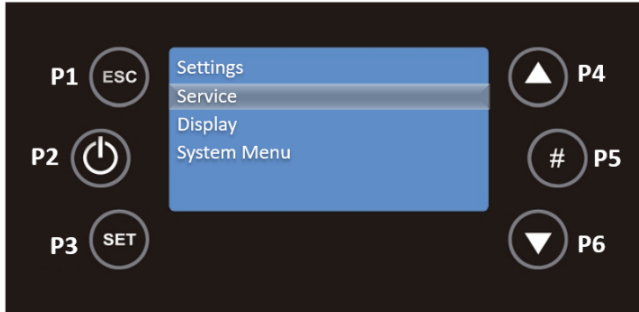
In the Display menu with P4 and P6 select the Firmware codes function by pressing on the P3 key. This function, for reference only, allows you to see the communication address of the control board, type of control board and firmware version.



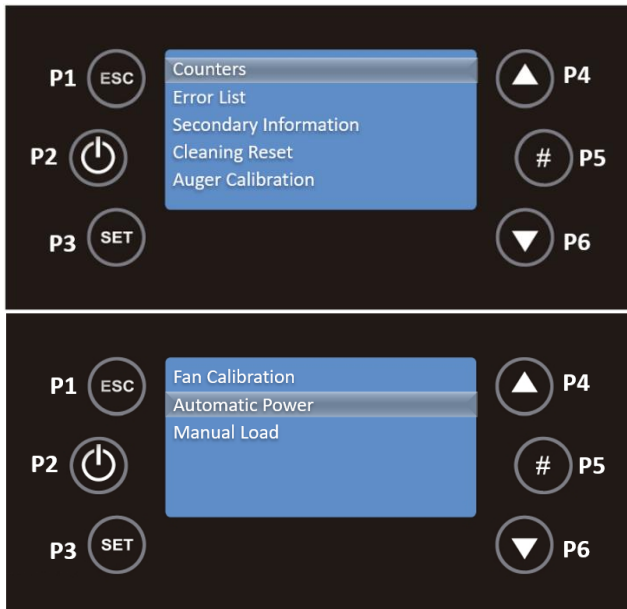
To return to the Display menu, press P1. Pressing this key twice will display the Settings, Display, Service and System menus.

11.4. Service Menu

By pressing the P3 key for 3 seconds, you will display the Settings, Service, Display and System menus. Use the P4 and P6 keys to select the required menu and then press P3 to confirm the choice, in this case the Service menu.

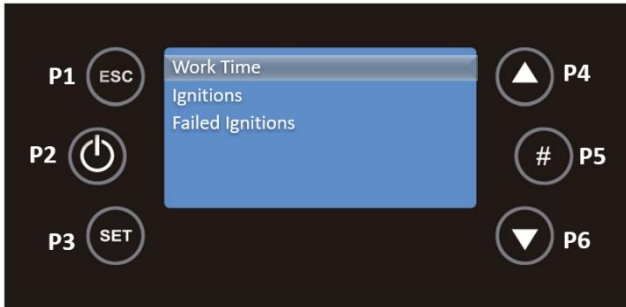


The following functions are available in this menu.

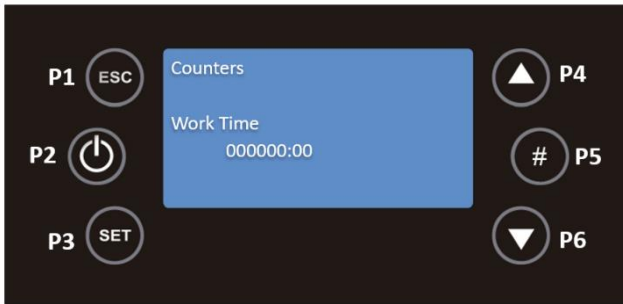


11.4.1. Counters

Select Counters, using the P3 key, to validate the entry in this submenu. This function allows consulting the working hours, the number of ignitions and the number of failed ignitions.

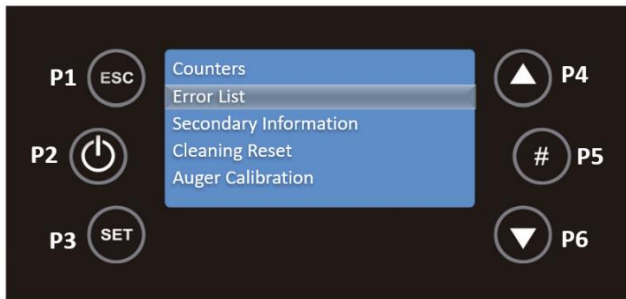


Using the P4 and P6 keys, select the submenu you wish to consult and press P3 to validate. To return to the Service menu, press P1.

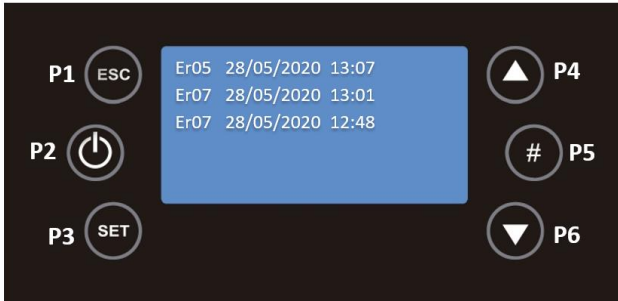


11.4.2. Error List

In the Service menu with P4 and P6 select the submenu Error list, pressing the P3 key to validate.

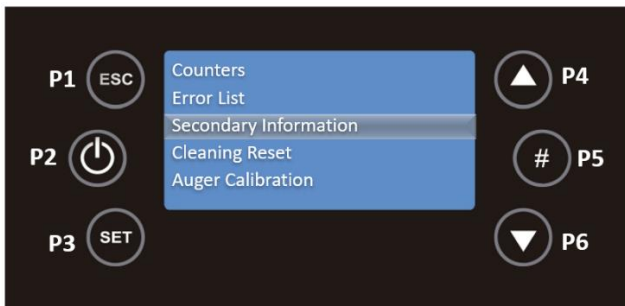


This submenu shows the last 10 errors that occurred, on each line the error code and the date and time when it occurred are displayed. To return to the Service menu press P1.

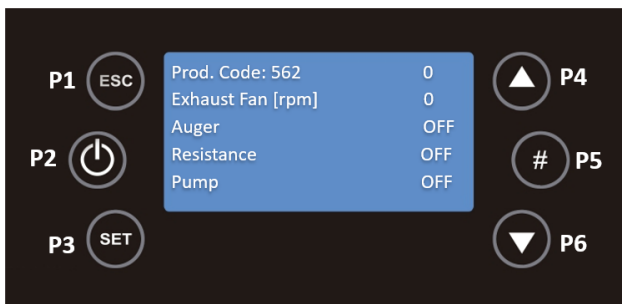


11.4.3. Secondary Information

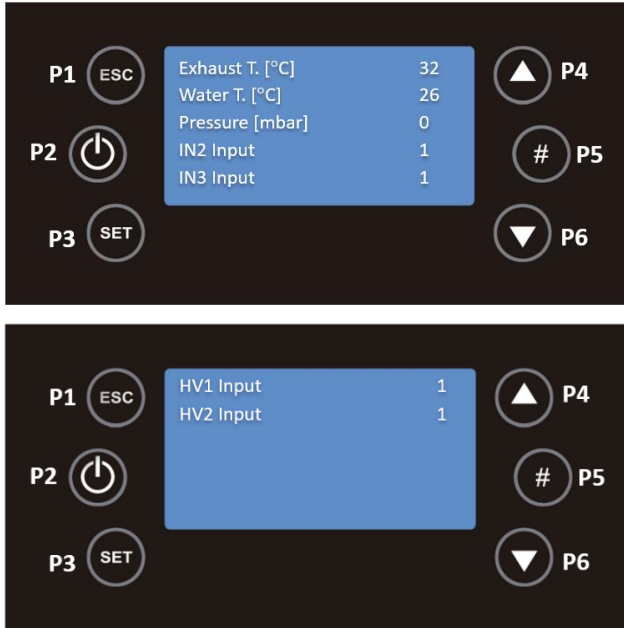
In the Service menu, select the Secondary Information submenu with P4 and P6 and then press the P3 key.



In this function you can check the product code, the status of the fan, the auger, the heating fan and the status of the outputs.

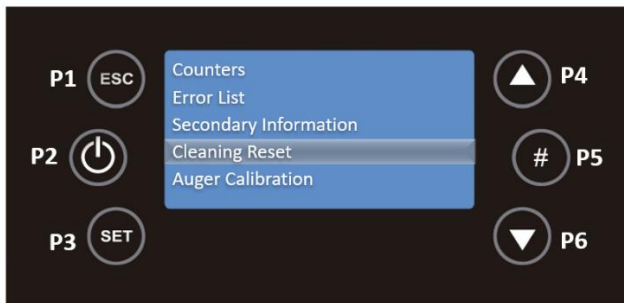


It is possible to query the exhaust temperature, ambient temperature and the status of the inputs. Whether the input status is open (0) or closed (1).

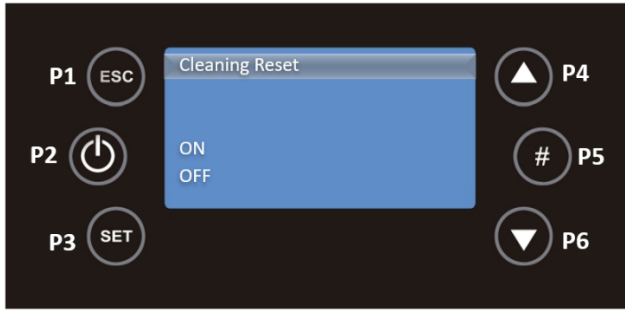


11.4.4. Cleaning Reset

In the Service menu with P4 and P6 select the Cleaning Reset function by pressing on the P3 key.

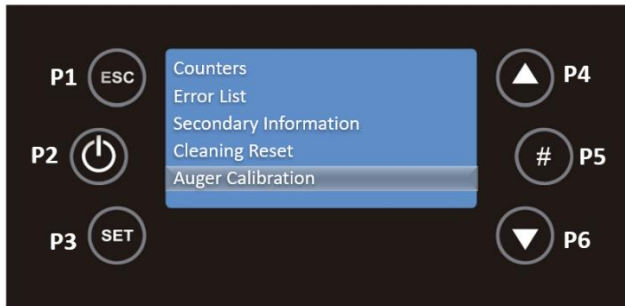


In this function you can switch this function on or off. To return to the Service menu, press P1.



11.4.5. Auger Calibration

In the Service menu with P4 and P6 select the Auger Calibration submenu, pressing the P3 key to validate.

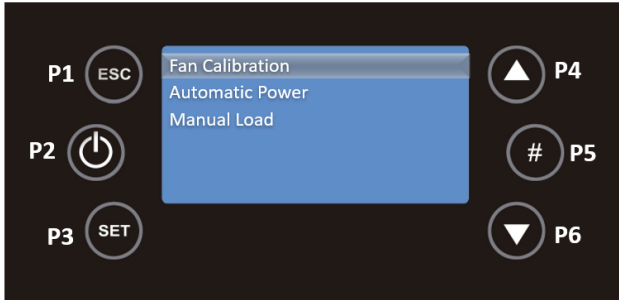


In this submenu, using the P4 and P6 buttons, you can adjust the quantity of pellets to be fed, between -7 (-14%) and 7 (+14%). To return to the Service menu, press P1.

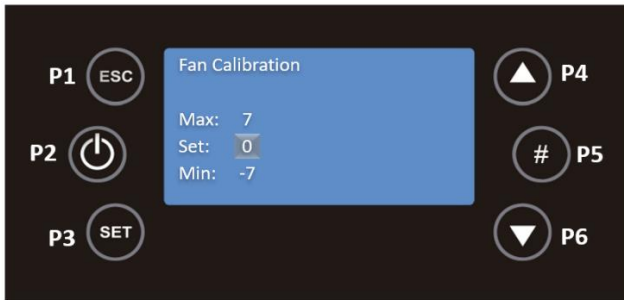


11.4.6. Fan Calibration

In the Service menu with P4 and P6 select the submenu Fan Calibration by pressing on the P3 key.

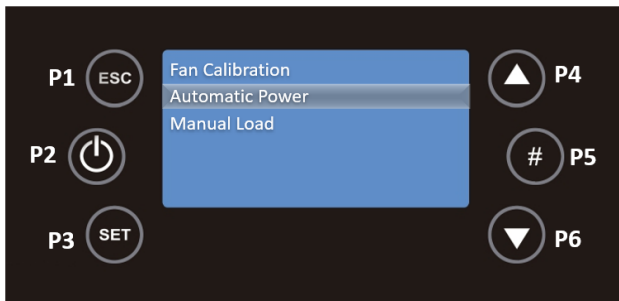


In this submenu with the keys P4 and P6 you can adjust the fan speed, between -7 (-21%) and 7 (+21%). To return to the Service menu, press P1.

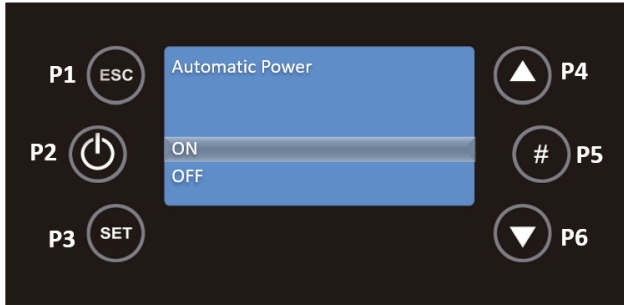


11.4.7. Automatic Power

In the Service menu with P4 and P6 select the Automatic Power submenu by pressing the P3 key.

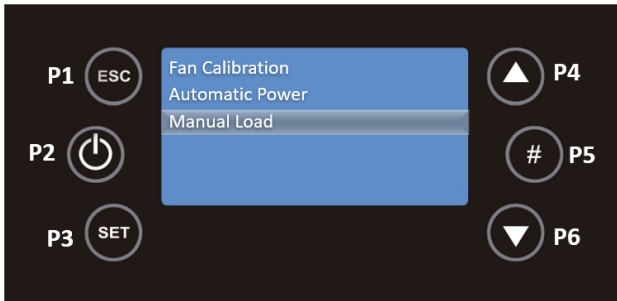


In this submenu you can set the combustion power only in automatic mode. If you set it, all the menus for changing the power will not be visible. With P4 and P6 you must select On or OFF and validate the choice with the P3 key.

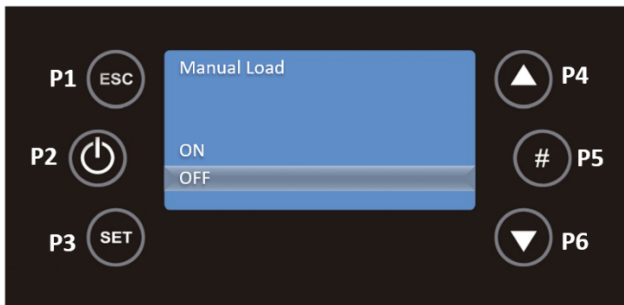


11.4.8. Manual Load

Select Manual Load, with the P3 key, to validate the entry in this submenu.



This function activates the pellet manual loading.

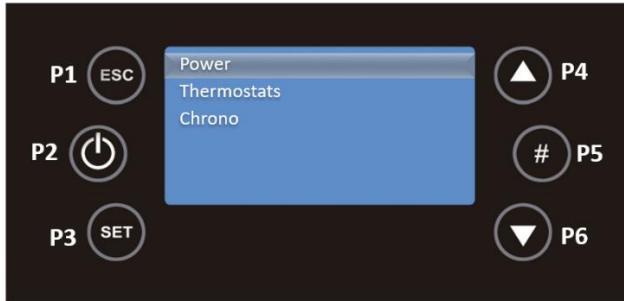


Pressing the P1 key twice will take you back to the main menus, Settings, Display, Service and System Menu.

SYSTEM MENU IS AN EXCLUSIVE ACCESS MENU FOR THE TECHNICAL SERVICE AND REQUIRES A PASSWORD.

11.5. Power Menu

Press the P3 key to access the following menus, Power, Thermostats and Chrono. Use the P4 and P6 keys to select the required menu and then press P3 to confirm the choice, in this case the Power menu.

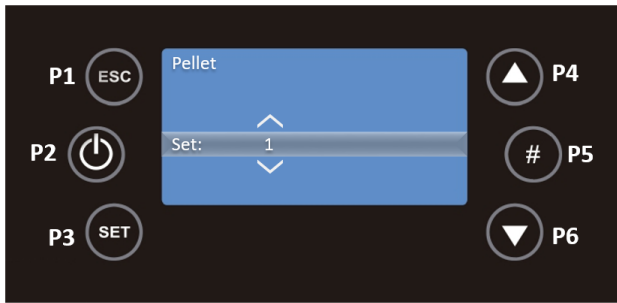


11.5.1. Pellet

Select Pellet with the P3 key, to validate the entry in this submenu.



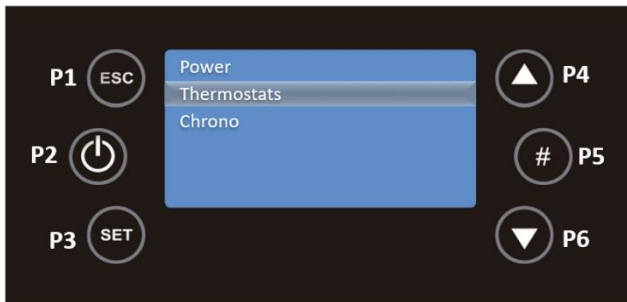
With the P4 and P6 keys you can modify the combustion power of the system.



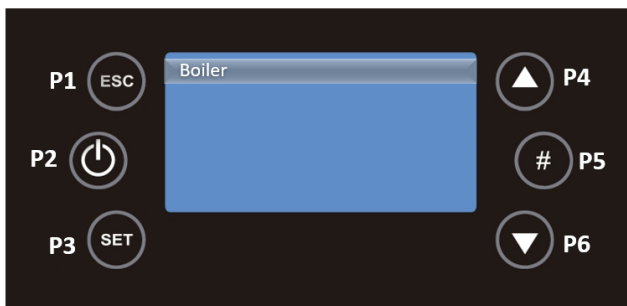
Press the P3 key to save your changes and use P1 to go back.

11.6. Thermostats Menu

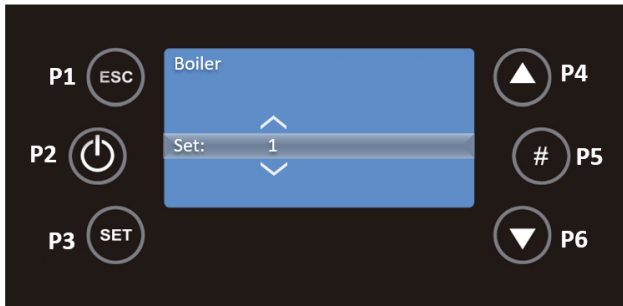
Press key P3 to access the Thermostats menu, using key P6 and then press on P3 to validate the choice of this menu.



In this menu select the Boiler submenu using the P3 key.



This submenu allows the boiler thermostat value to be modified, using the P4 and P6 keys. The minimum and maximum values can be set.

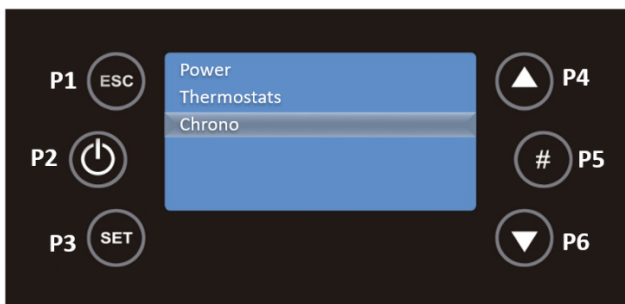


Press the P3 key to save your changes and use P1 to go back.

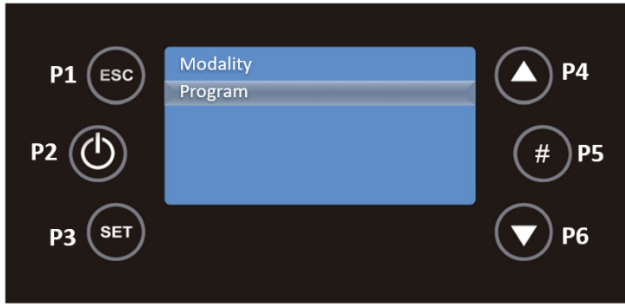
11.7. Chrono Menu

The unit has a time scheduler that allows the stove to switch on and off automatically. It can be daily (you can select the day of the week you want and set up to 3 different times for the respective day), weekly (you can select up to 3 times during a day, the same program will be applied every day of the week) and weekend (you can select 3 times during the day for weekdays and weekends).

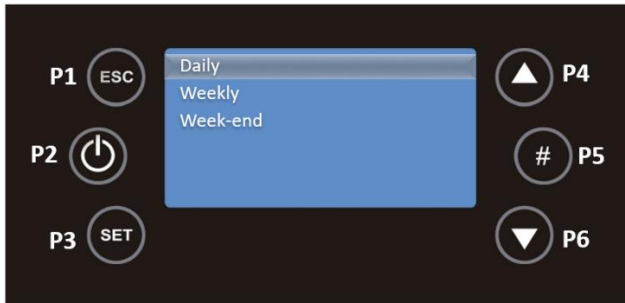
In the main screen, press the P3 key to access the menus, Power, Thermostats and Chrono. Use the P4 and P6 keys to select the Chrono menu and then press P3 to confirm the choice.



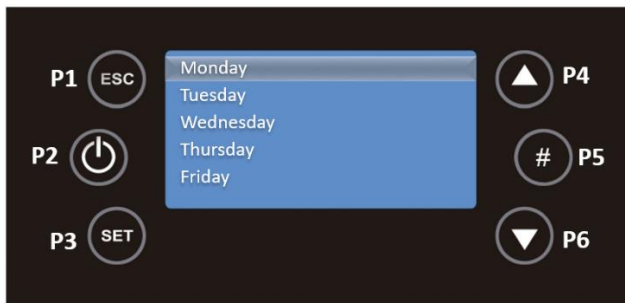
You must then enter the Programme submenu, using the P6 key to select and P3 to validate the choice.

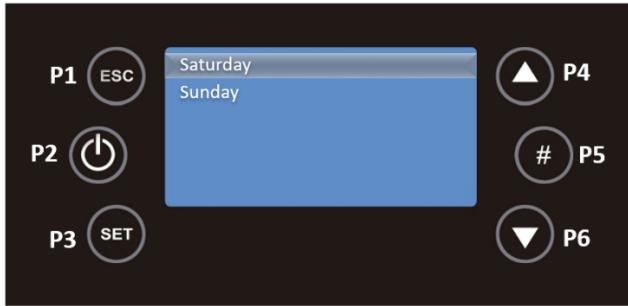


Then use the P4 and P6 keys to select Daily, Weekly or Weekend. You must press P3 to validate your choice.

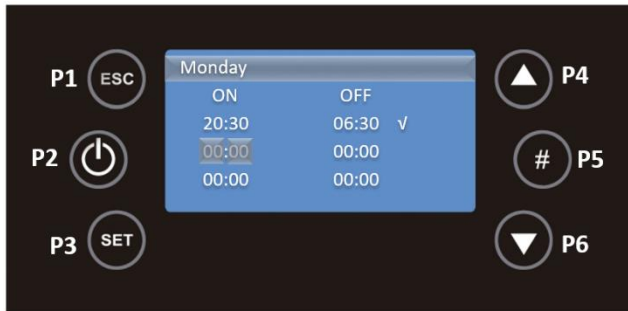


For the Daily programme, you must use the P4 and P6 keys to select the day of the week, in this case the programme for Monday, and then press P3 to validate your choice.





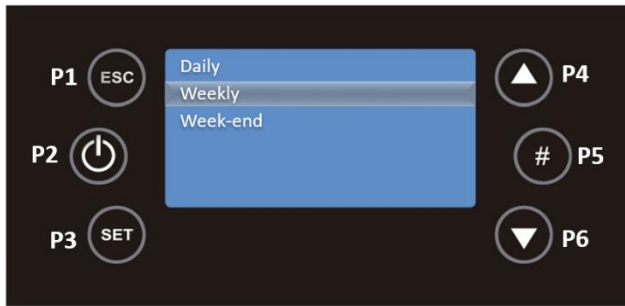
You must press P3 and this option will be in editable mode, flashing. Press P4 and P6 to select the desired time and then use the P3 key to save. Repeat this process for the time at which the unit is to shut down, using P4 and P6. Finally, activate the interval by pressing P5, and a check mark will appear to the right of the interval.



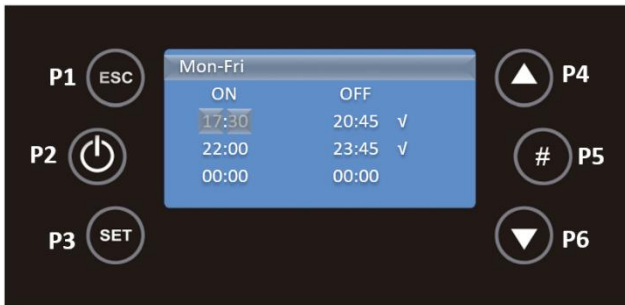
In the image above the system will turn on at 20:30 on Monday and will turn off at 06:30 on Tuesday. When programmes are developed around midnight with the intention of starting operation the day before and finishing operation the next day it will be relevant:

- Set the OFF time of the day before at 23:59;
- Set the ON time for the next day at 00:00.

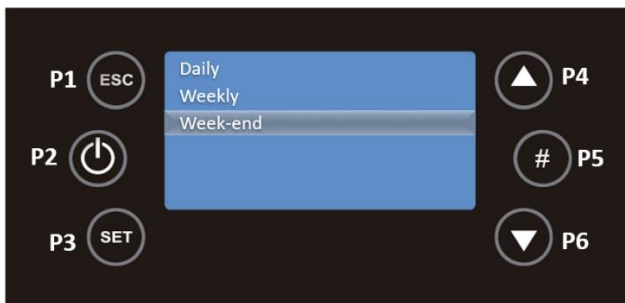
For the Weekly programme, the programmes are the same for every day of the week, from Monday to Sunday. Use the P4 and P6 buttons to select weekly from the Programme submenu and press P3 to confirm the choice.



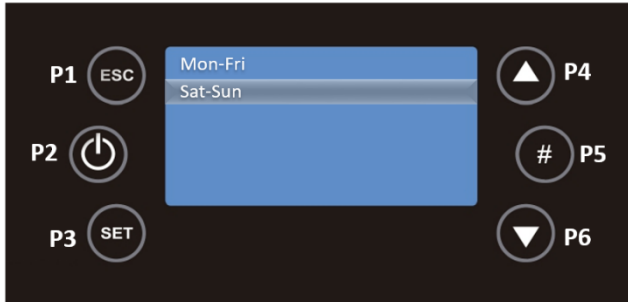
You must press P3 and this option will be in editable mode, flashing. Press P4 and P6 to select the desired time and then use the P3 key to save. Repeat this process for the time at which the unit is to shut down, using P4 and P6. Finally, activate the interval by pressing P5, and a check mark will appear to the right of the interval.



For the Weekend programme, you must, with the P4 and P6 keys, select Weekend and press P3 to validate your choice.



For this mode, you must choose between the Monday to Friday and Saturday to Sunday time slots by pressing the P3 key.

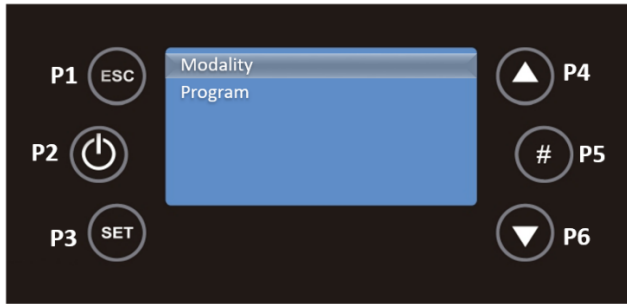


You must press P3 and this option will be in editable mode, flashing. Press P4 and P6 to select the desired time and then use the P3 key to save. Repeat this process for the time at which the unit is to shut down, using P4 and P6. Finally, activate the interval by pressing P5, and a check mark will appear to the right of the interval.

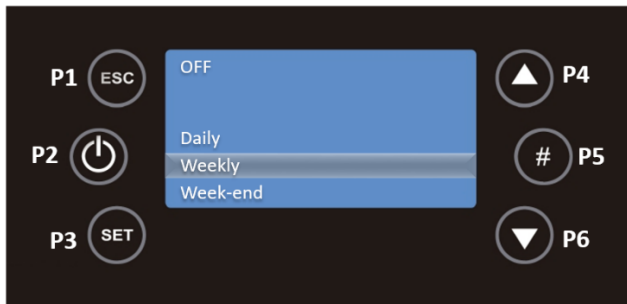


AFTER DEFINING THE PROGRAMMES, IT IS NECESSARY TO DEFINE WHICH MODE YOU WANT TO ACTIVATE.

In the main screen, press the P3 key to access the menus, Power, Thermostats and Chrono. Use the P4 and P6 keys to select the Chrono menu and then press P3 to confirm the choice.



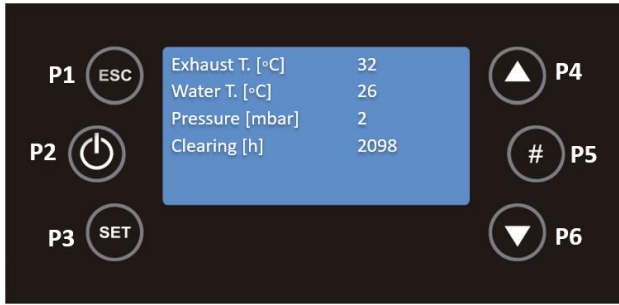
By selecting Mode with the P3 key you can select which Chrono mode you want. Use the P4 and P6 keys to select between Daily, Weekly and Weekend, use the P2 key to activate/deactivate the choice and P3 to save the changes.



After activating the mode, the main screen will have Led **D**, **W** or **WE** active in the upper right corner.

11.8. Info Menu

In this menu the user can view some information about the device, such as measured values and aspects relating to the electronics. In the initial menu, press the P5 key once, and the menu will appear.



With the P4 and P6 keys you can scroll through the different variables. The values displayed are the values measured On-Line.

The following table explains the meaning of each of the variables.

Exhaust T. [°C]	Read in degrees Celsius (°C) it tells you the exhaust temperature monitored by the probe.
Water T. [°C]	This is read in degrees Celsius (°C) and gives the water temperature.
Fan [rpm]	Read in rpm, it tells you the rotation speed of the fan.
Auger [s]	Read in seconds and within 4 seconds the auger is active and feeding pellet to the burner.
Service [h]	Read in hour's shows the number of hours remaining to show faults due to lack of maintenance. These must be reset by the technical service during maintenance. The maintenance period must respect the kilos of pellets burned.
Working hours [h]	Read in hours tells you the number of hours in Run Mode, Modulation and Safety Mode.
Ignition [nr]	Read in number of occurrences informs how many ignitions have been carried out since they were reset to zero.
Cod. Artic.	Product Code.

Table 7 - Meaning of the variables

12. Alarm / Failure / Recommendation List – Columbus Control

Anomalies

- Sond – Probe’s anomaly during the control in Check Up.
- Ignition Block – The message appears if the system has been is turned off during Ignition (after Preload) by an external device: the system will stop only when it goes in Run Mode.
- Link Error – Lack of communication between the LCD or K control panels and the control board.
- Cleaning On – Periodic cleaning in progress.
- Flashing Hours - Wrong time and date in the event of prolonged power failure.

THE ANOMALIES DO NOT ORIGINATE THE SHUTDOWN OF THE EQUIPMENT.

To switch off the device, in case of emergency, you must do the normal shutdown of the equipment. To do this, press the off button for 3 seconds and allow it to deactivate until the word off appears on the display.

All alarms cause the machine to switch off with information about the error and activation of the alarm led. It will be necessary to reset the alarm and restart. To reset the machine, press the “On/Off” button for 3 to 4 seconds until you hear a beep accompanied by the message “Reset alarms in progress”.

If the resetting of alarms is successful, new information is displayed - Reset alarms Successful. In the Off state, if for any reason the smoke temperature rises above 85°C, the unit enters deactivation mode.

Alarm	Code		Troubleshooting
Pellet drum temperature is too high	Er01	110 °C, even with the equipment OFF	<ul style="list-style-type: none"> - Room fan not working - call for service - Thermostat defective - call for service - Ventilation defective
Pressure regulator alarm	Er02	Door open, draught too low or extractor fault for 180 sec. Only visible if puller is set to ON.	<ul style="list-style-type: none"> - Close door and remove faulty pressure switch - Faulty exhaust pipe obstruction or extractor
Extinguishing for exhaust under temperature	Er03	Temperature below 55°C (Th03)	<ul style="list-style-type: none"> - Pellet reservoir is empty - Faulty thermocouple
Extinguishing for exhaust over temperature	Er05	Over 300 °C	<ul style="list-style-type: none"> - Room fan does not work or is at a low power level - increase level to maximum (if problem persists call for service) - Insufficient extraction - Excess pellets - Faulty smoke sensor
Encoder fan error: no Encoder signal	Er07	No rpm signals. Allows unlocking and working by voltage in a provisional way P25=0	<ul style="list-style-type: none"> - Check connection - Check that the fan is not blocked - After remedying the fault, you must select operating mode P25=2 again
Encoder fan error: Combustion Fan regulation failed	Er08	Encoder has signal but failed regulation. Can be released and working temporarily by voltage P25=0	<ul style="list-style-type: none"> - Blockage of exhaust pipe or defective extractor - After remedying the fault, you must select operating mode P25=2 again
Failed ignition	Er12	Maximum time: 900 s and exhaust temperature below 50°C	<ul style="list-style-type: none"> - Empty auger channel - restarting - Ignition resistance burnt out - replace resistance - Firing basket incorrectly placed - Exhaust temperature did not exceed the value set on activation

Lack of voltage supply	Er15	Lack of voltage supply for more than 50 min	<ul style="list-style-type: none"> - Check supply voltage with your electricity supplier - Check the simultaneous use of electrical appliances - In the event of a short power failure (<10s) the stove continues to operate normally - If the system was in the ON state and the power failure occurs for more than 10s and less than 50 min, the stove will switch on after blackout
Communication error RS485	Er16		<ul style="list-style-type: none"> - Check connection between board and display
Open door error (First Advance 12kW only)	Er44	Door opens for 60 sec	<ul style="list-style-type: none"> - Close the door - remove the error
Service	Service	Maximum Hours: 2100 hr (T66) planned for maintenance achieved	<ul style="list-style-type: none"> - Contact your installer for occasional preventive maintenance of the equipment

THE MAINTENANCE FAULT ("SERVICE" MESSAGE ON THE DISPLAY) MEANS THAT THE STOVE HAS MORE THAN 2100 HOURS IN SERVICE. THE CUSTOMER MUST HAVE THE EQUIPMENT SERVICED AND ONLY THEN RESET THE HOUR METER TO ELIMINATE THE FAULT MESSAGE. THIS DOES NOT INFLUENCE THE NORMAL OPERATION OF THE EQUIPMENT; IT IS ONLY A WARNING.



WARNING!

TO SWITCH OFF THE APPLIANCE IN AN EMERGENCY, YOU SHOULD NORMALLY SHUT DOWN THE EQUIPMENT.



WARNING!

THE APPLIANCE WILL BE HOT DURING OPERATION, SO THAT CARE SHOULD BE TAKEN ESPECIALLY WITH THE DOOR GLASS AND THE DOOR HANDLE.

13. Operating the unit

To start operating the Free-Standing Pellet Fire unit, press the start/stop button for 3s. The display should indicate "Lighting" until this completion of this phase.

The *pellets* are fed through the supply channel to the burning basket (combustion chamber), where they will be ignited using a heat resistor. This process may take between 5 and 10 minutes, depending on whether the worm screw used to push through the *pellets* has been previously filled with fuel or is empty. Upon completion of the ignition phase, the word "On" should appear on the *display*. The heating power can be adjusted at any time by pressing the power selection button for approximately 1 second. You can choose between five pre-set power levels. The selected power is indicated on the display. The initial power status at each start-up will correspond to the power level set during the last cycle operation.



Important Note: Before starting up the unit, check to determine if the deflector plate is **CORRECTLY** positioned.

13.1. Stop

The stop sequence of the unit is started by pressing the start/stop key for 3s. The display will show "**Desactivação**" (Disabling) until full completion of this phase. The extractor will remain active until the fume temperature of 40°C is reached, to guarantee that all the material has been burnt.

13.2. Turning off the unit

The unit should only be disconnected after its full stop. Make sure that the display shows "**Off**" before disconnecting the unit. If necessary, disconnect the power cable from the mains.

14. Instruction for installing the casings

Before installing the casings, you should check immediately whether the packing is complete and in perfect condition, possible damages or lack of element must be reported and marked before proceeding with its installation.

This manual will demonstrate how to install the casings in the Hidro 12, 17 and 23 equipment's.

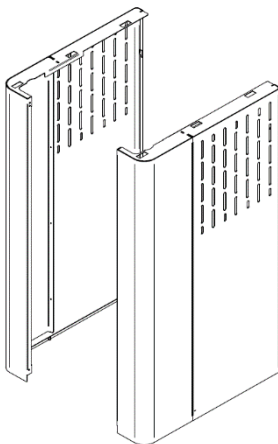
IMPORTANT NOTICE: Before installing the casings, the machine must be switched off (remove the mains plug).

14.1. Installation of the casings Hidro 12

Two configurations of casings can be installed on the Hidro 12 unit, Fuji Oak and Himalaia. In order to assemble the casings, the installer must have a star screwdriver (PH2 screw) available.

To assemble these models, it is necessary that each of the kits contain the following parts:

- **Fuji Oak**



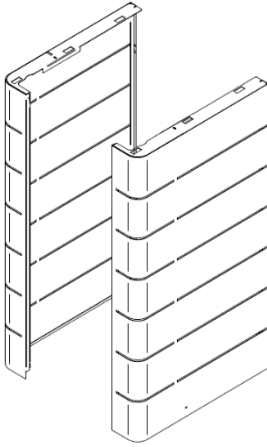
Set of casings



2 Screws Din 7981 4,2x9,5
(CO0704132501019)

Figure 18 - Kit Fuji Oak

- **Himalaia**



Set of casings – chosen colour



2 Screws Din 7981 4,2x9,5
(CO0704132501019)

Figure 19 - Kit Himalaia

a) First remove the upper part of the equipment, undoing the pins (1) of the springs (2) existing in the structure by exerting force in the upwards direction.

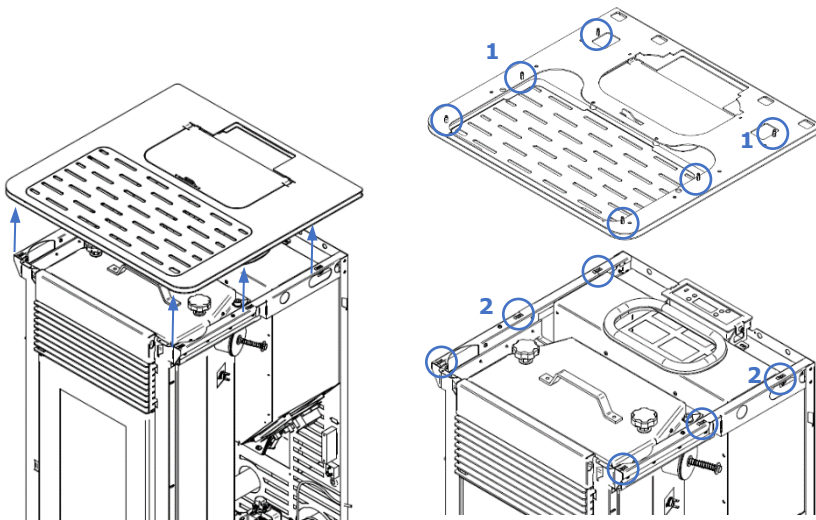


Figure 20 - Removing the top Hidro 12

b) Next, you must fit the tabs of the casings into the slots in the pillars and in the rear grille of the equipment.

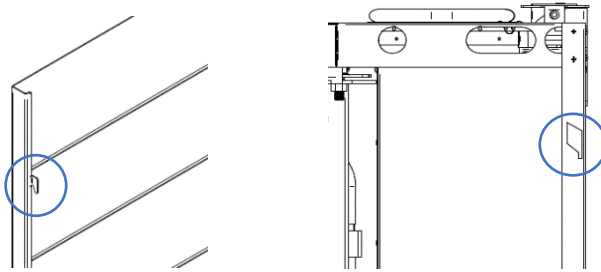


Figure 21 - Assembly of the casings Hidro 12

The front tabs of the casings (3) must be fitted into the slots at the front of the unit (4). The rear tabs (5) fit into the slots on the sides of the unit (6).

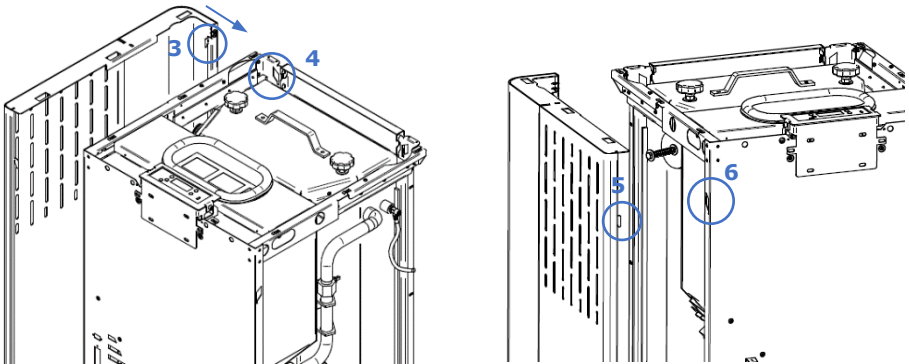


Figure 22 - Assembly of the casings Hidro 12

It should then be moved downwards so that the casings stay fixed (7).

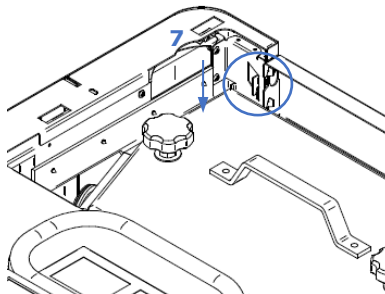


Figure 23 - Assembly of the casings Hidro 12

c) Finally, two screws Din 7981 4.2x9.5 should be used to fix the casings to the top of the equipment (8).

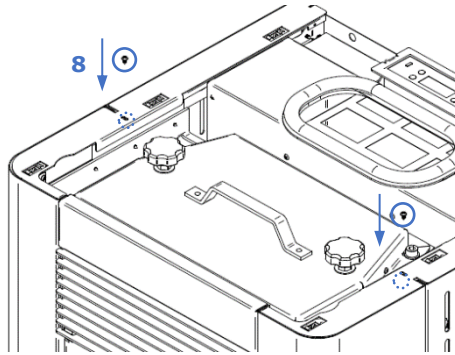


Figure 24 - Assembly of the casings Hidro 12

d) Put the top back on the stove. To ensure that the top is properly positioned, it has four pins (1) at the bottom which must fit into the springs on the frame.

Important Note: A small amount of force may be required to properly engage the pins in the frame.

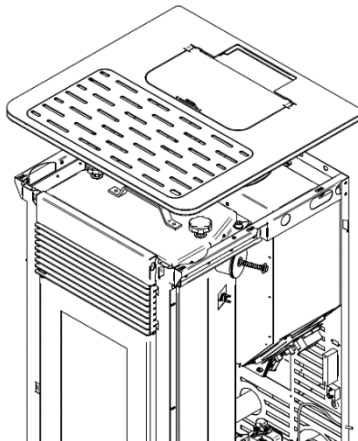
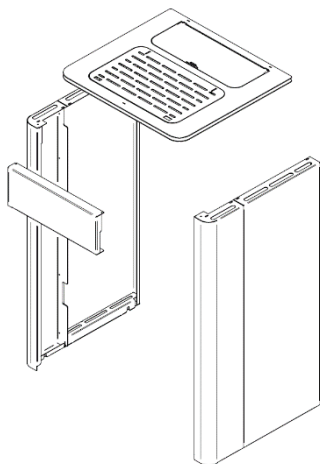


Figure 25 - Assembly of the casings Hidro 12

14.2. Installation of the casings Hidro 17 and Hidro 23

In the Hidro 17 equipment, it is possible to install several configurations of casings, Fuji Oak, Himalaya, K2 and Douro. In order to assemble the casings, the installer must have a star screwdriver (PH2 screw) available. To assemble these models, it is necessary that each of the kits contain the following parts:

- **Fuji Oak**



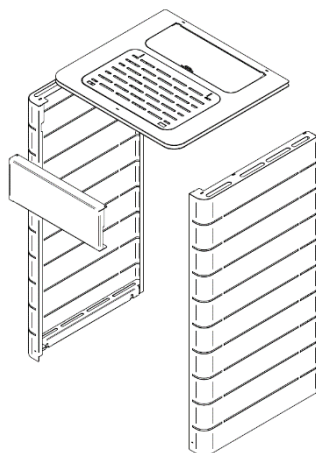
Set of casings



10 Screws Din 7981 4,2x9,5
(CO0704132501019)

Figure 26 - Kit Fuji Oak

- **Himalaia**



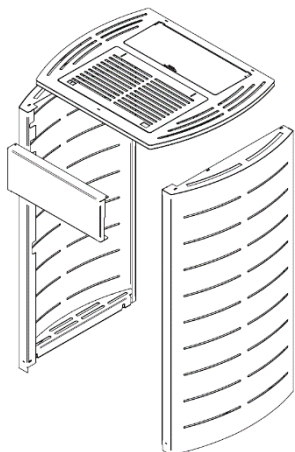
Set of casings – chosen colour



10 Screws Din 7981 4,2x9,5
(CO0704132501019)

Figure 27 - Kit Himalaia

- **K2**



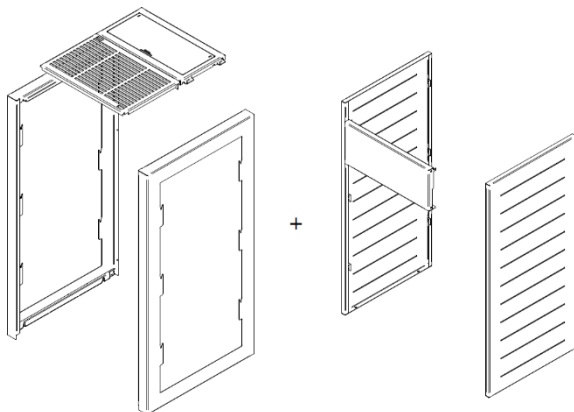
Set of casings – chosen colour



10 Screws Din 7981 4,2x9,5
(CO0704132501019)

Figure 28 - Kit K2

- **Douro**



Set of casings – chosen colour



18 Screws Din 7981 4,2x9,5
(CO0704132501019)

Figure 29 - Kit Douro

14.2.1. Casings Fuji Oak, Himalaia and K2

a) To fit the upper front cover (A), it must be placed on the front of the unit and then two Din 7981 4.2x9.5 screws accessible through the upper part of the unit (1) and another two screws in the lower part of the front cover (2) must be tightened.

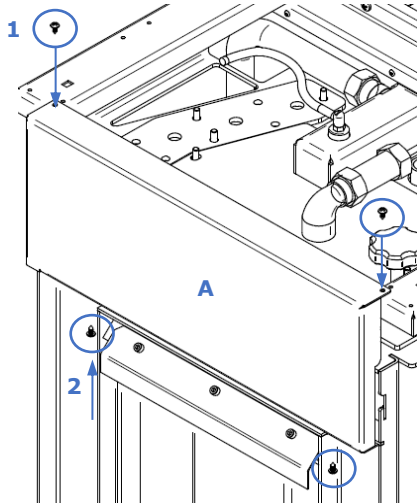


Figure 30 - Fitting the front cover Hidro 17 and Hidro 23

b) Then, to assemble the side covers you must fit the bottom holes of the covers (3) in the guides found on the bottom of the machine (4).

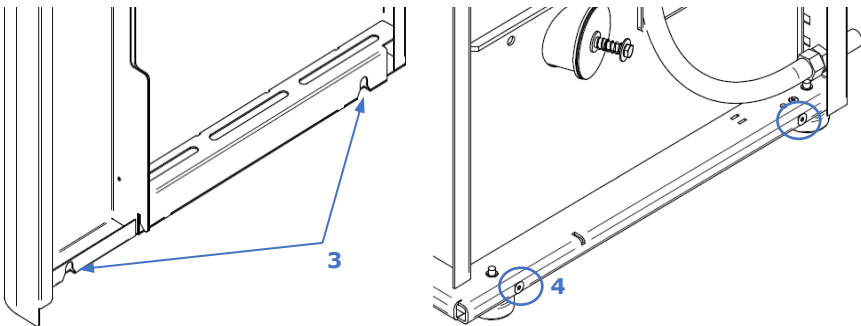


Figure 31 - Assembly of the casings Hidro 17 and Hidro 23

c) You should slide the side casing downwards during assembly and then tighten it using four DIN 7981 screws 4.2x9.5 (5). The same procedure should be repeated for the two side casings.

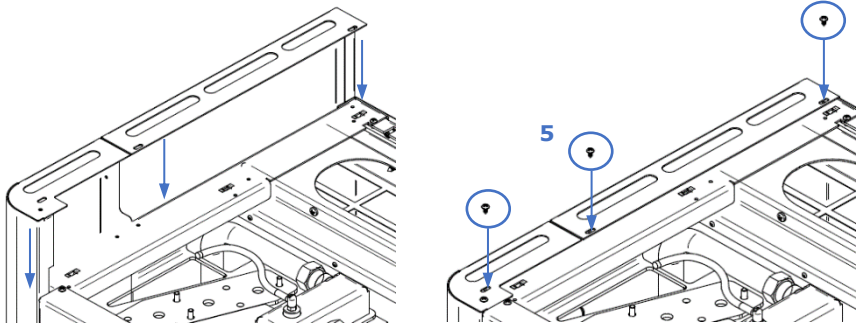


Figure 32 - Assembly of the casings Hidro 17 and Hidro 23

d) To finish, you must place the upper lid on top of the equipment.

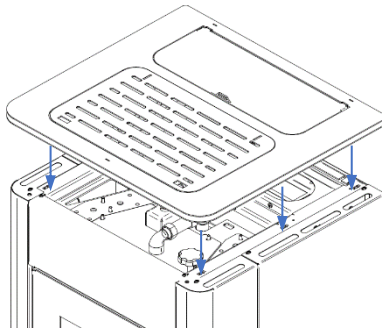


Figure 33 - Assembly of the casings Hidro 17 and Hidro 23

To ensure that the worktop is fitted correctly, the worktop has six pins (6) at the bottom which must engage with the springs in the frame (7). A small amount of force may be required to correctly engage the pins in the frame.

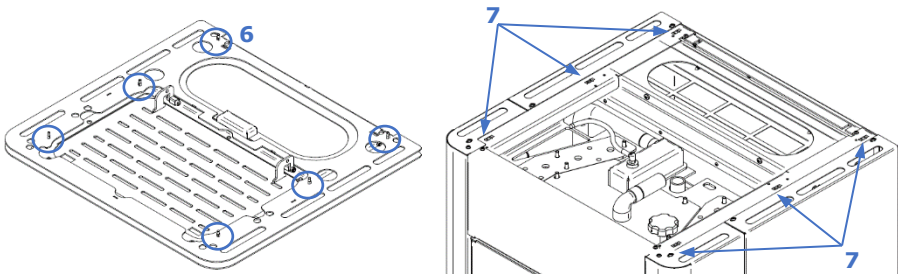


Figure 34 - Assembly of the casings Hidro 17 and Hidro 23

14.2.2. Casings Douro

a) To fit the upper front cover (A), it must be placed on the front of the unit and then two Din 7981 4.2x9.5 screws accessible through the upper part of the unit (1) and another two screws in the lower part of the front cover (2) must be tightened.

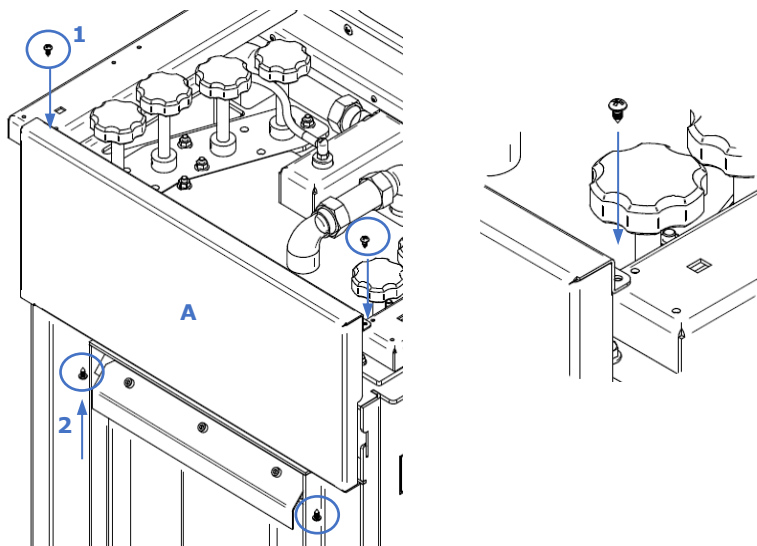


Figure 35 - Fitting the front cover Hidro 17 and Hidro 23

b) Next, fit the top plate using four Din 7981 4.2x9.5 screws (3).

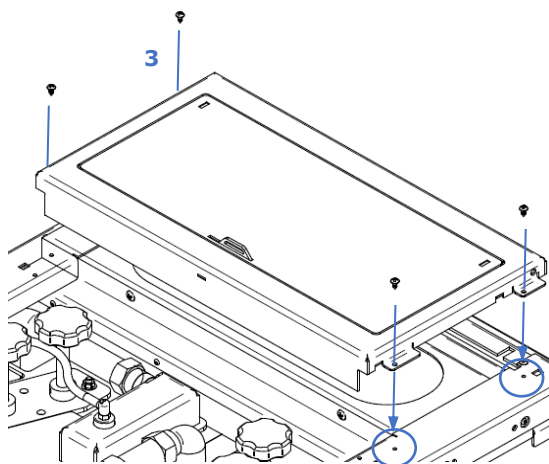


Figure 36 - Assembly of the casings Hidro 17 and Hidro 23

c) To assemble the side covers, the existing holes in the covers and in the upper part of the equipment must be matched, using two screws DIN 7981 4.2x9.5 (4).

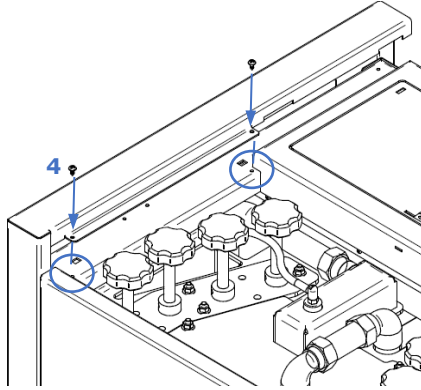


Figure 37 - Assembly of the casings Hidro 17 and Hidro 23

d) You must also fasten the covers in the existing hole in the rear grille of the equipment with three screws DIN 7981 4.2x9.5 (5). Repeat the same procedure for the two side covers.

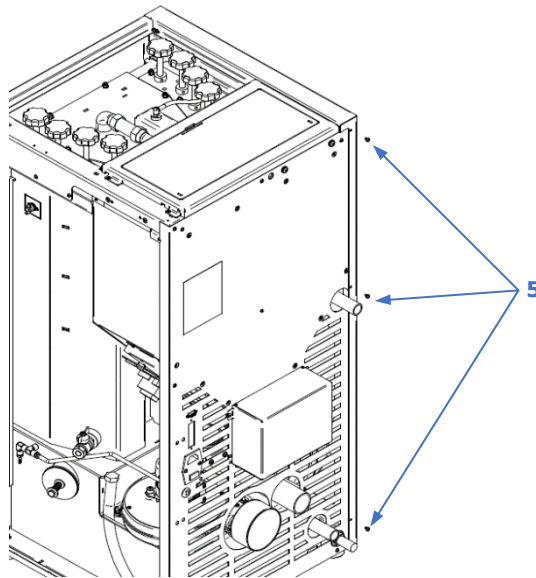


Figure 38 - Assembly of the casings Hidro 17 and Hidro 23

e) To fit the side frames, insert the six side frames (6) into the grooves in the frame of the side frames (7).

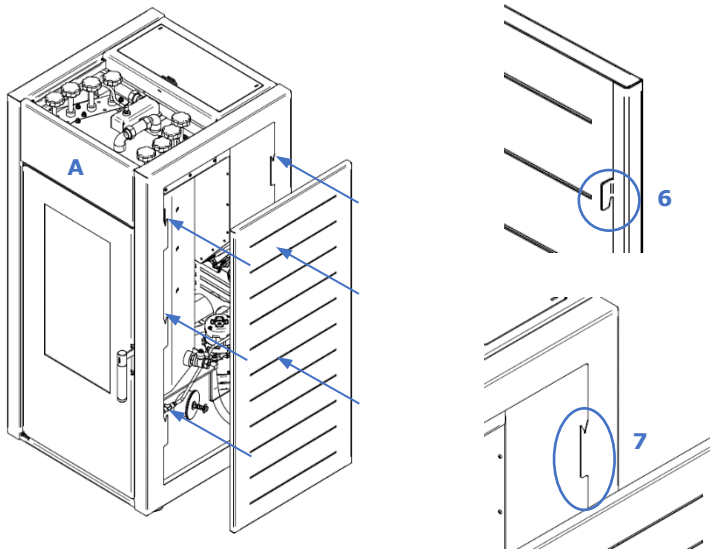


Figure 39 - Assembly of the casings Hidro 17 and Hidro 23



Important note: if you have Douro 17 and Douro 23 covers in stock, you may apply the side covers to the Hidro 17 and Hidro 23 machines. However, the upper front cover, part A in Figure 39, must be ordered separately in the corresponding colour.

f) To finish, you must place the upper grid on the appliance (8).

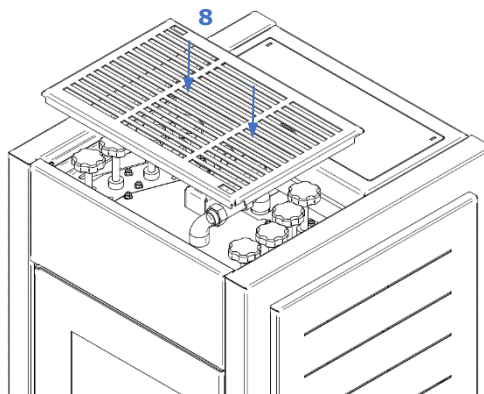


Figure 40 - Assembly of the casings Hidro 17 and Hidro 23

14.3. Pellet reservoir lid

The pellet reservoir is opened by sliding the bolt sideways (Figure 41-a) and lifting the lid (Figure 41-b).

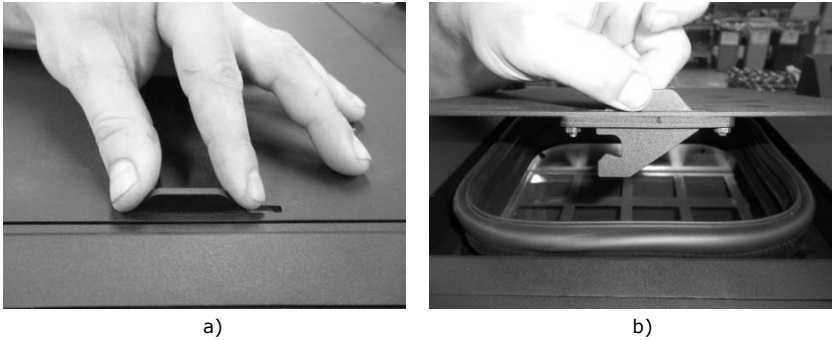


Figure 41 - Opening the lid

14.4. Filling the pellet reservoir

- 1 – Open the pellet reservoir lid at the top of the unit, as shown in Figure 41.
- 2 – Pour the pellets into the reservoir, as shown in Figure 42.



Figure 42 - Refilling the pellet reservoir

- 3 - Turn on the unit and close the lid, pressing it down as shown in Figure 41-a.

15. Installation and operation with the remote control (chrono-thermostat) – not included in free standing units

The free-standing pellet fire units are mass produced with the command device (display). Alternatively, they can be used with a generic remote-control unit (programmable thermostat).

Note: the remote control is usually accompanied by a manual. To use the remote control, you must install an interface (Figure 43-c).

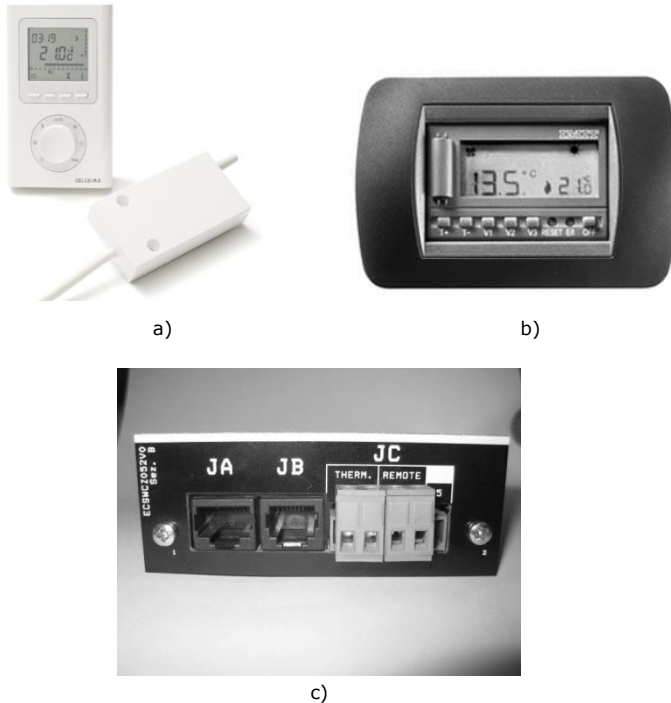


Figure 43 - Remote control (programmable thermostat) and connection interface – both not included

This board has two entries "remote" and "therm" to connect the chrono-thermostat into the "remote" the user of the start (closed contact NC) and stop (open contact NO) the boiler.

If connecting into the "thermostat" This will only change the power of the machine between minimum output (open contact NO) and maximum power (closed contact NC).

Note: the external command, as a rule, comes with a manual.

In the case of **wireless** remote control is necessary to connect the two wires as shown in the following figure:

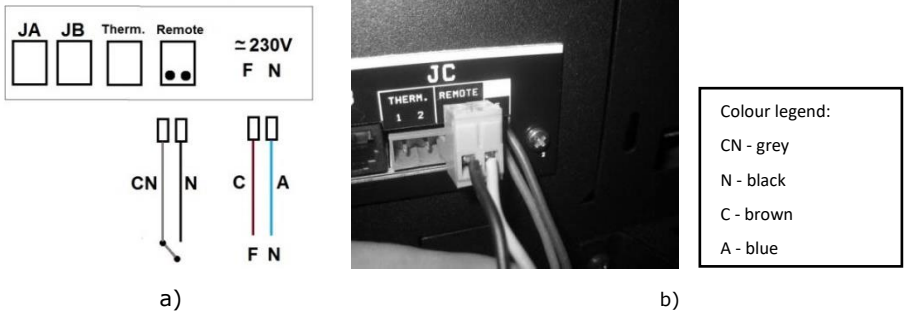


Figure 44 - Connection of the wireless remote control

For the **wired** remote control, the black and grey wires must be connected to the receiver as shown in the following figure.

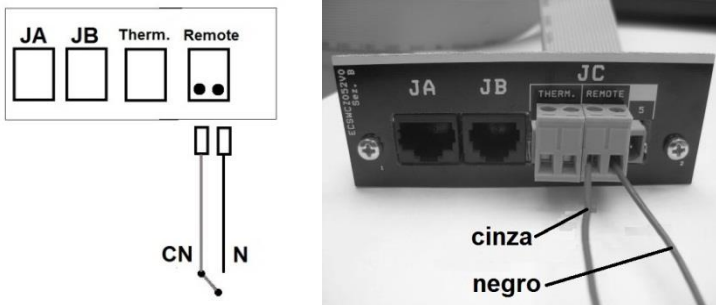


Figure 45 - Wired remote command connection

15.1. Instructions for remote control assembly

1 – Turn off the unit at the power switch, remove both the right-side cover of the free-standing pellet fire unit (Figure 46-a) and the plate with the micro joints (Figure 46-b).



a)



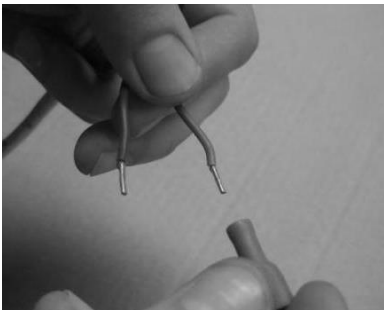
b)

2 – Remove the unit's terminals phase (F) and neutral (N).

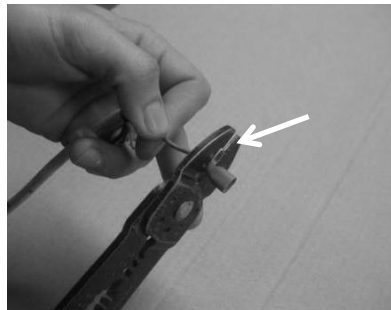


c)

3 – Rivet the terminals of the 220V wire supplying power to the transmitter.

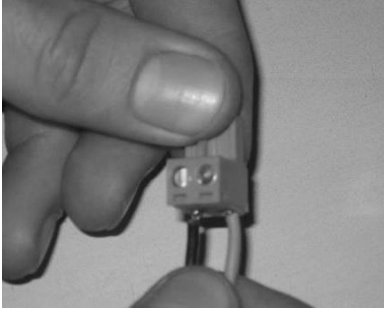


d)



e)

4 – Connect the wires on the ON/OFF connector contact (Figure 46-f); direct the wires through the cable gland to the interior of the unit (Figure 46-g);

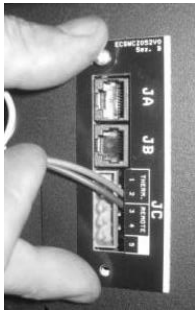


f)



g)

5 – Assemble the interface at the appropriate location on the unit and position the remote control (On/Off contact) switch to "remote" (Figure 46-h);

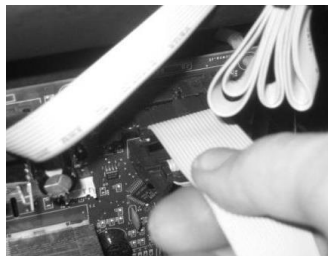


h)



i)

6 – Connect the interface cable to the electronic plate on the communication card (Servizi 5J).



j)

Figure 46 - Installation of the chrono-thermostat

16. Maintenance

16.1. Daily Maintenance

The Solzaima free standing pellet fire unit requires careful maintenance. The most important thing is to remove the ash from the pellet burning area at regular intervals. This can be easily done by using a simple household vacuum cleaner. It should be cleaned after burning approximately 30 kg (Hidro 12) / 60 kg (Hidro 17 and Hidro 23) of pellets.

Note: However, before cleaning, the power of the unit must be turned off and the unit should be allowed to cold off to prevent any accident.

16.2. Weekly Maintenance

- **Hidro 12**

To perform maintenance on the back boiler model, clean the airflow pipes. To do this, raise the lid on the top of the unit (Figure 47) and then lift the levers inside several times (Figure 47) to make the dirt accumulated inside the pipes fall out.

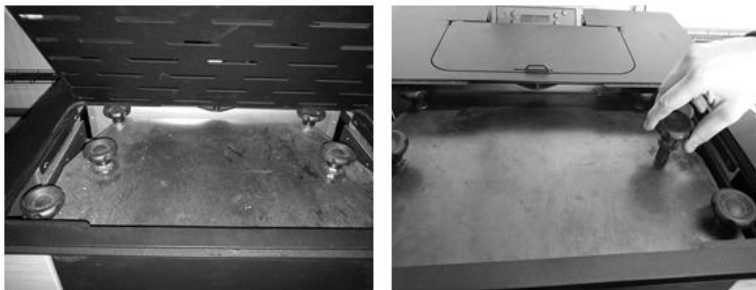


Figure 47 - Cleaning the turbulators

Then clean the inside of the unit using a steel brush on the surfaces where dirt has accumulated (Figure 48).



Figure 48 - Cleaning the interior

Then remove the burning basket (Figure 49-a) and the ash basket (Figure 49-b) and vacuum the ashes from both. The interior of the unit must also be cleaned by opening the hatch, as shown in figure. Finally, assemble the parts in the reverse to which they were removed and close the unit door.



a)



b)

Figure 49 - a) Burning basket; b) Ash basket

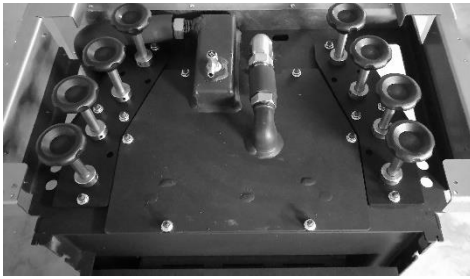


WARNING! The maintenance task frequency depends on the quality of the pellets.

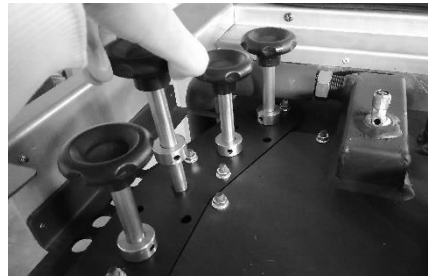
Note: See the warning label and read the maintenance instructions in chapter 18.

- **Hidro 17 and Hidro 23**

To carry out this maintenance on the water version salamander, the air passages must be cleaned. To do this, lift the lid on the upper part of the stove (Figure 50-a) and then turn and lift several times the knobs (Figure 50), in order to remove the dirt accumulated inside the pipes.



a)



b)

Figure 50 - Cleaning the turbulators

The inside of the stove should then be cleaned by scrubbing the surfaces with a steel brush (Figure 51).



Figure 51 - Cleaning the interior

Then remove the burner basket (Figure 52-a) and the ash basket (Figure 52-b) and vacuum the ashes out of both. It is also necessary to clean the inside of the stove by opening the front trap, as shown in Figure 54. Finally, assemble the parts in the reverse order in which they were removed and close the door of the appliance.



a)



b)

Figure 52 - a) Burning basket; b) Ash basket



Figure 53 - Cleaning the burning basket



a)



b)

Figure 54 - Cleaning the interior of the unit

⚠ WARNING! The maintenance task frequency depends on the quality of the pellets.

Note: See the warning label and read the maintenance instructions in chapter 18.

16.3. Additional cleaning

- **Hidro 12**

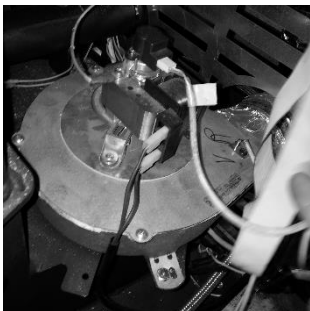
Additional cleaning should be performed for every 1300-1700 lbs (600-800 kg) of pellets consumed.

To carry out this cleaning it is necessary to remove the side covers to gain access to the side covers of the combustion chamber, remove the cover and with the hoover remove the ash. With the help of a steel brush 20-25 mm in diameter and 80 cm long clean the fume passage area (Figure 55).

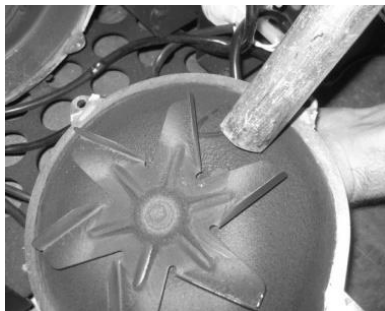


Figure 55 - Cleaning Vacuum the interior

If it is found that the fume extraction is not being carried out under optimum conditions, we recommend cleaning the extractor by vacuuming inside as indicated in Figure 56-a and Figure 56-b. However, this operation is recommended at least once a year.



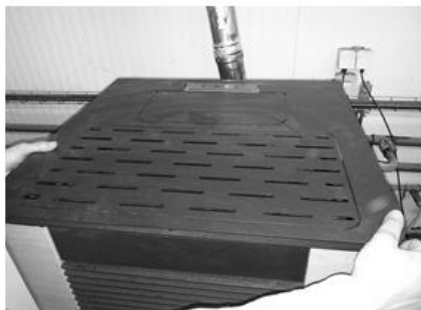
a)



b)

Figure 56 - Cleaning Vacuum the interior

The tubes through which the gases and the respective turbulators circulate must be cleaned. To do that, open the cover located in the upper part of the equipment (Figure 57-a and Figure 57-b) and remove the 4 knobs that fix the upper cover (Figure 57-c and Figure 57-d). Then pull the turbulators upwards (Figure 57-e). A Hoover should be used to clean this area (Figure 57-f) and the inside of the pipes can be cleaned with a steel brush. The removed turbulators should also be cleaned with a steel brush). To put the turbulators back on, proceed in the opposite way to that shown in the figures.



a)



b)



c)



d)



e)



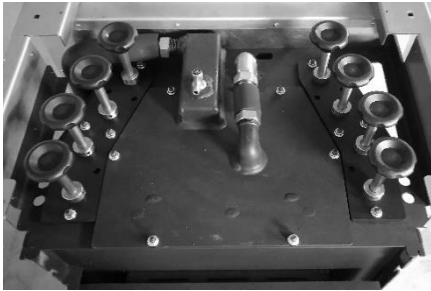
f)

Figure 57 - Cleaning the air flow pipes and turbulators

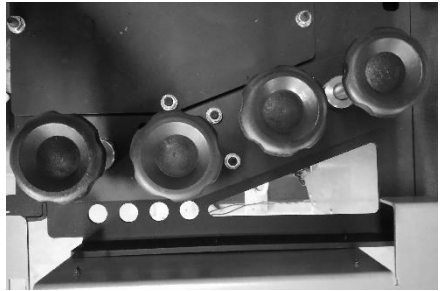
- **Hidro 17 and Hidro 23**

For each 1300-1700 lbs (600-800 kg) of pellets consumed, an additional cleaning should be carried out on the tubes through which the air circulates and the respective turbulators. To do this, open the cover on the upper part of the equipment (Figure 58-a) and remove the six wing nuts that secure each turbulator group (Figure 58-b and Figure 58-c).

Then pull the turbulators upwards (Figure 58-d, Figure 58-e and Figure 58-f). A Hoover should be used to clean this area (Figure 58-g) and the inside of the pipes can be cleaned with a steel brush (Figure 58-h). The turbulators that have been removed should also be cleaned with a steel brush (Figure 58-i). To put the turbulators back on, proceed in the opposite way to that shown in the figures.



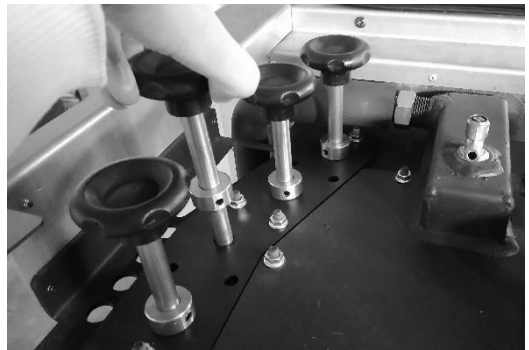
a)



b)



c)



d)

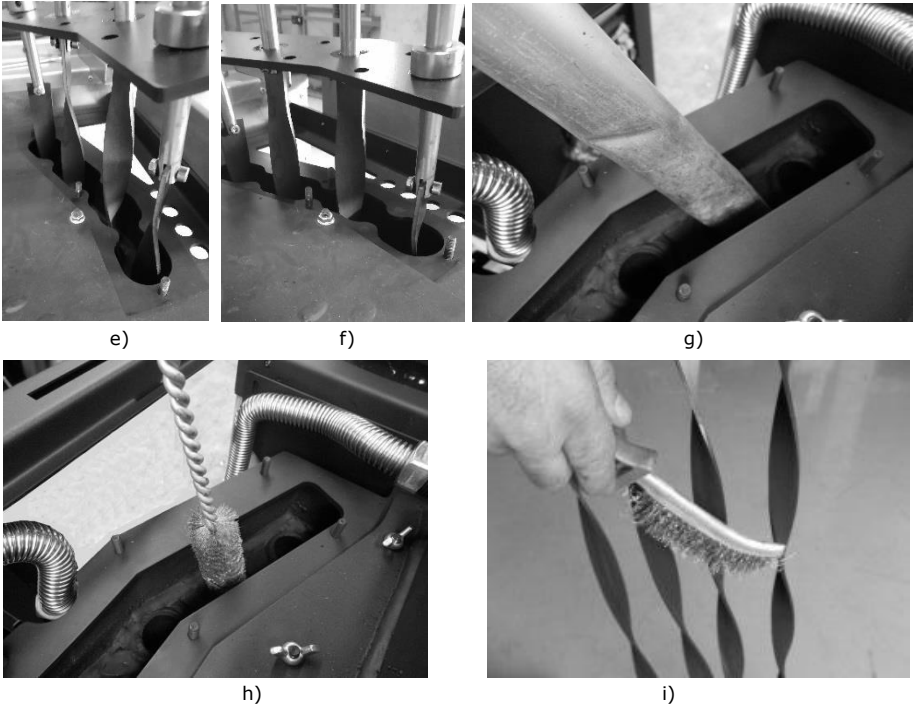


Figure 58 - Cleaning the air flow pipes and turbulators

If it is found that fume extraction is not being carried out under the best conditions, we recommend cleaning the extractor as shown in Figure 59. However, this operation is recommended at least once a year.

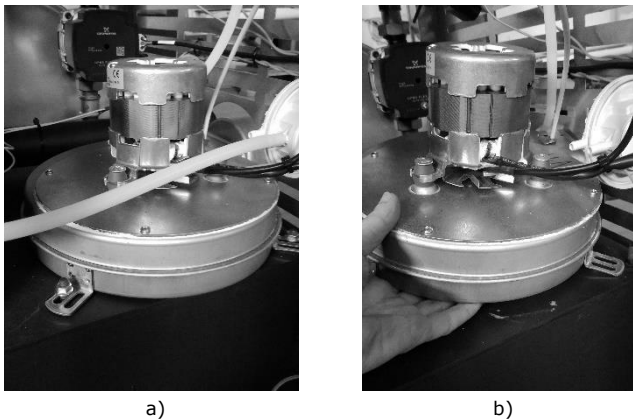


Figure 59 - a) Remove the screws; b) Remove the extractor

16.4. Cleaning the glass

The glass may only be cleaned with the unit completely cold, and using an appropriate product, as per the instructions for use. You should prevent the product from reaching the sealing ring and painted metal parts so that no undesirable oxidation occurs. The sealing ring is glued, so should not be exposed to moisture from water or cleaning products.

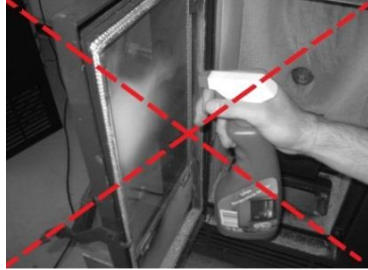


Figure 60 - Incorrect cleaning of the glass



a)



b)

Figure 61 - Cleaning of the glass: a) moisten a soft cloth with liquid; b) clean the glass with the cloth



WARNING! The maintenance task frequency depends on the quality of the pellets.

Note: See the warning label and read the maintenance instructions in chapter 18.

17. Maintenance Plan and Log

To ensure the proper operation of the unit, maintenance operations must be performed, as described in Chapter 16 of this Instruction Manual. There are specific maintenance tasks that must be performed by authorised technicians only. Please contact the person responsible for installing the unit. To make sure the warranty remains valid, the maintenance operations performed on this unit must comply with the frequency requirement specified in the manual, and the service technician must fill and sign the maintenance log.

Client data:

Name:	
Address:	
Telephone:	
Model:	
Serial Number:	

Company/SAT: _____		
Technical: _____		
Dates: _____		
Service hours of boiler: _____		
Quantity of pellets burned: _____		
Task	Check	Obs.
Clean burner		
Clean smoke circuit and turbulators		
Vacuum pellet tank sawdust		
Check pressure of the expansion vessel		
Check safety valve 3 bar		
Check the fluid on the hydraulic circuit		
Clean the smoke extractor		
Check and clean the inspection T		
Clean chimney		
check the tightening of the screws		
Check engine cap pellet hopper		
		Signature/stamp

Company/SAT: _____		
Technical: _____		
Dates: _____		
Service hours of boiler: _____		
Quantity of pellets burned: _____		
Task	Check	Obs.
Clean burner		
Clean smoke circuit and turbulators		
Vacuum pellet tank sawdust		
Check pressure of the expansion vessel		
Check safety valve 3 bar		
Check the fluid on the hydraulic circuit		
Clean the smoke extractor		
Check and clean the inspection T		
Clean chimney		
check the tightening of the screws		
Check engine cap pellet hopper		
		Signature/stamp

Company/SAT: _____		
Technical: _____		
Dates: _____		
Service hours of boiler: _____		
Quantity of pellets burned: _____		
Task	Check	Obs.
Clean burner		
Clean smoke circuit and turbulators		
Vacuum pellet tank sawdust		
Check pressure of the expansion vessel		
Check safety valve 3 bar		
Check the fluid on the hydraulic circuit		
Clean the smoke extractor		
Check and clean the inspection T		
Clean chimney		
check the tightening of the screws		
Check engine cap pellet hopper		
		Signature/stamp

Company/SAT: _____		
Technical: _____		
Dates: _____		
Service hours of boiler: _____		
Quantity of pellets burned: _____		
Task	Check	Obs.
Clean burner		
Clean smoke circuit and turbulators		
Vacuum pellet tank sawdust		
Check pressure of the expansion vessel		
Check safety valve 3 bar		
Check the fluid on the hydraulic circuit		
Clean the smoke extractor		
Check and clean the inspection T		
Clean chimney		
check the tightening of the screws		
Check engine cap pellet hopper		
		Signature/stamp

Company/SAT: _____		
Technical: _____		
Dates: _____		
Service hours of boiler: _____		
Quantity of pellets burned: _____		
Task	Check	Obs.
Clean burner		
Clean smoke circuit and turbulators		
Vacuum pellet tank sawdust		
Check pressure of the expansion vessel		
Check safety valve 3 bar		
Check the fluid on the hydraulic circuit		
Clean the smoke extractor		
Check and clean the inspection T		
Clean chimney		
check the tightening of the screws		
Check engine cap pellet hopper		
Signature/stamp _____		

Company/SAT: _____		
Technical: _____		
Dates: _____		
Service hours of boiler: _____		
Quantity of pellets burned: _____		
Task	Check	Obs.
Clean burner		
Clean smoke circuit and turbulators		
Vacuum pellet tank sawdust		
Check pressure of the expansion vessel		
Check safety valve 3 bar		
Check the fluid on the hydraulic circuit		
Clean the smoke extractor		
Check and clean the inspection T		
Clean chimney		
check the tightening of the screws		
Check engine cap pellet hopper		
Signature/stamp _____		

Company/SAT: _____		
Technical: _____		
Dates: _____		
Service hours of boiler: _____		
Quantity of pellets burned: _____		
Task	Check	Obs.
Clean burner		
Clean smoke circuit and turbulators		
Vacuum pellet tank sawdust		
Check pressure of the expansion vessel		
Check safety valve 3 bar		
Check the fluid on the hydraulic circuit		
Clean the smoke extractor		
Check and clean the inspection T		
Clean chimney		
check the tightening of the screws		
Check engine cap pellet hopper		
Signature/stamp _____		

Company/SAT: _____		
Technical: _____		
Dates: _____		
Service hours of boiler: _____		
Quantity of pellets burned: _____		
Task	Check	Obs.
Clean burner		
Clean smoke circuit and turbulators		
Vacuum pellet tank sawdust		
Check pressure of the expansion vessel		
Check safety valve 3 bar		
Check the fluid on the hydraulic circuit		
Clean the smoke extractor		
Check and clean the inspection T		
Clean chimney		
check the tightening of the screws		
Check engine cap pellet hopper		
Signature/stamp _____		

Company/SAT: _____		
Technical: _____		
Dates: _____		
Service hours of boiler: _____		
Quantity of pellets burned: _____		
Task	Check	Obs.
Clean burner		
Clean smoke circuit and turbulators		
Vacuum pellet tank sawdust		
Check pressure of the expansion vessel		
Check safety valve 3 bar		
Check the fluid on the hydraulic circuit		
Clean the smoke extractor		
Check and clean the inspection T		
Clean chimney		
check the tightening of the screws		
Check engine cap pellet hopper		
Signature/stamp _____		

Company/SAT: _____		
Technical: _____		
Dates: _____		
Service hours of boiler: _____		
Quantity of pellets burned: _____		
Task	Check	Obs.
Clean burner		
Clean smoke circuit and turbulators		
Vacuum pellet tank sawdust		
Check pressure of the expansion vessel		
Check safety valve 3 bar		
Check the fluid on the hydraulic circuit		
Clean the smoke extractor		
Check and clean the inspection T		
Clean chimney		
check the tightening of the screws		
Check engine cap pellet hopper		
Signature/stamp _____		

Company/SAT: _____		
Technical: _____		
Dates: _____		
Service hours of boiler: _____		
Quantity of pellets burned: _____		
Task	Check	Obs.
Clean burner		
Clean smoke circuit and turbulators		
Vacuum pellet tank sawdust		
Check pressure of the expansion vessel		
Check safety valve 3 bar		
Check the fluid on the hydraulic circuit		
Clean the smoke extractor		
Check and clean the inspection T		
Clean chimney		
check the tightening of the screws		
Check engine cap pellet hopper		
Signature/stamp _____		

Company/SAT: _____		
Technical: _____		
Dates: _____		
Service hours of boiler: _____		
Quantity of pellets burned: _____		
Task	Check	Obs.
Clean burner		
Clean smoke circuit and turbulators		
Vacuum pellet tank sawdust		
Check pressure of the expansion vessel		
Check safety valve 3 bar		
Check the fluid on the hydraulic circuit		
Clean the smoke extractor		
Check and clean the inspection T		
Clean chimney		
check the tightening of the screws		
Check engine cap pellet hopper		
Signature/stamp _____		

Company/SAT: _____		
Technical: _____		
Dates: _____		
Service hours of boiler: _____		
Quantity of pellets burned: _____		
Task	Check	Obs.
Clean burner		
Clean smoke circuit and turbulators		
Vacuum pellet tank sawdust		
Check pressure of the expansion vessel		
Check safety valve 3 bar		
Check the fluid on the hydraulic circuit		
Clean the smoke extractor		
Check and clean the inspection T		
Clean chimney		
check the tightening of the screws		
Check engine cap pellet hopper		
Signature/stamp _____		

Company/SAT: _____		
Technical: _____		
Dates: _____		
Service hours of boiler: _____		
Quantity of pellets burned: _____		
Task	Check	Obs.
Clean burner		
Clean smoke circuit and turbulators		
Vacuum pellet tank sawdust		
Check pressure of the expansion vessel		
Check safety valve 3 bar		
Check the fluid on the hydraulic circuit		
Clean the smoke extractor		
Check and clean the inspection T		
Clean chimney		
check the tightening of the screws		
Check engine cap pellet hopper		
Signature/stamp _____		

Company/SAT: _____		
Technical: _____		
Dates: _____		
Service hours of boiler: _____		
Quantity of pellets burned: _____		
Task	Check	Obs.
Clean burner		
Clean smoke circuit and turbulators		
Vacuum pellet tank sawdust		
Check pressure of the expansion vessel		
Check safety valve 3 bar		
Check the fluid on the hydraulic circuit		
Clean the smoke extractor		
Check and clean the inspection T		
Clean chimney		
check the tightening of the screws		
Check engine cap pellet hopper		
Signature/stamp _____		

Company/SAT: _____		
Technical: _____		
Dates: _____		
Service hours of boiler: _____		
Quantity of pellets burned: _____		
Task	Check	Obs.
Clean burner		
Clean smoke circuit and turbulators		
Vacuum pellet tank sawdust		
Check pressure of the expansion vessel		
Check safety valve 3 bar		
Check the fluid on the hydraulic circuit		
Clean the smoke extractor		
Check and clean the inspection T		
Clean chimney		
check the tightening of the screws		
Check engine cap pellet hopper		
Signature/stamp _____		

Company/SAT: _____		
Technical: _____		
Dates: _____		
Service hours of boiler: _____		
Quantity of pellets burned: _____		
Task	Check	Obs.
Clean burner		
Clean smoke circuit and turbulators		
Vacuum pellet tank sawdust		
Check pressure of the expansion vessel		
Check safety valve 3 bar		
Check the fluid on the hydraulic circuit		
Clean the smoke extractor		
Check and clean the inspection T		
Clean chimney		
check the tightening of the screws		
Check engine cap pellet hopper		
Signature/stamp _____		

Company/SAT: _____		
Technical: _____		
Dates: _____		
Service hours of boiler: _____		
Quantity of pellets burned: _____		
Task	Check	Obs.
Clean burner		
Clean smoke circuit and turbulators		
Vacuum pellet tank sawdust		
Check pressure of the expansion vessel		
Check safety valve 3 bar		
Check the fluid on the hydraulic circuit		
Clean the smoke extractor		
Check and clean the inspection T		
Clean chimney		
check the tightening of the screws		
Check engine cap pellet hopper		
Signature/stamp _____		

Company/SAT: _____		
Technical: _____		
Dates: _____		
Service hours of boiler: _____		
Quantity of pellets burned: _____		
Task	Check	Obs.
Clean burner		
Clean smoke circuit and turbulators		
Vacuum pellet tank sawdust		
Check pressure of the expansion vessel		
Check safety valve 3 bar		
Check the fluid on the hydraulic circuit		
Clean the smoke extractor		
Check and clean the inspection T		
Clean chimney		
check the tightening of the screws		
Check engine cap pellet hopper		
Signature/stamp _____		

Company/SAT: _____		
Technical: _____		
Dates: _____		
Service hours of boiler: _____		
Quantity of pellets burned: _____		
Task	Check	Obs.
Clean burner		
Clean smoke circuit and turbulators		
Vacuum pellet tank sawdust		
Check pressure of the expansion vessel		
Check safety valve 3 bar		
Check the fluid on the hydraulic circuit		
Clean the smoke extractor		
Check and clean the inspection T		
Clean chimney		
check the tightening of the screws		
Check engine cap pellet hopper		
Signature/stamp _____		

Company/SAT: _____		
Technical: _____		
Dates: _____		
Service hours of boiler: _____		
Quantity of pellets burned: _____		
Task	Check	Obs.
Clean burner		
Clean smoke circuit and turbulators		
Vacuum pellet tank sawdust		
Check pressure of the expansion vessel		
Check safety valve 3 bar		
Check the fluid on the hydraulic circuit		
Clean the smoke extractor		
Check and clean the inspection T		
Clean chimney		
check the tightening of the screws		
Check engine cap pellet hopper		
_____ Signature/stamp		

Company/SAT: _____		
Technical: _____		
Dates: _____		
Service hours of boiler: _____		
Quantity of pellets burned: _____		
Task	Check	Obs.
Clean burner		
Clean smoke circuit and turbulators		
Vacuum pellet tank sawdust		
Check pressure of the expansion vessel		
Check safety valve 3 bar		
Check the fluid on the hydraulic circuit		
Clean the smoke extractor		
Check and clean the inspection T		
Clean chimney		
check the tightening of the screws		
Check engine cap pellet hopper		
_____ Signature/stamp		

Company/SAT: _____		
Technical: _____		
Dates: _____		
Service hours of boiler: _____		
Quantity of pellets burned: _____		
Task	Check	Obs.
Clean burner		
Clean smoke circuit and turbulators		
Vacuum pellet tank sawdust		
Check pressure of the expansion vessel		
Check safety valve 3 bar		
Check the fluid on the hydraulic circuit		
Clean the smoke extractor		
Check and clean the inspection T		
Clean chimney		
check the tightening of the screws		
Check engine cap pellet hopper		
_____ Signature/stamp		

Company/SAT: _____		
Technical: _____		
Dates: _____		
Service hours of boiler: _____		
Quantity of pellets burned: _____		
Task	Check	Obs.
Clean burner		
Clean smoke circuit and turbulators		
Vacuum pellet tank sawdust		
Check pressure of the expansion vessel		
Check safety valve 3 bar		
Check the fluid on the hydraulic circuit		
Clean the smoke extractor		
Check and clean the inspection T		
Clean chimney		
check the tightening of the screws		
Check engine cap pellet hopper		
_____ Signature/stamp		

Company/SAT: _____		
Technical: _____		
Dates: _____		
Service hours of boiler: _____		
Quantity of pellets burned: _____		
Task	Check	Obs.
Clean burner		
Clean smoke circuit and turbulators		
Vacuum pellet tank sawdust		
Check pressure of the expansion vessel		
Check safety valve 3 bar		
Check the fluid on the hydraulic circuit		
Clean the smoke extractor		
Check and clean the inspection T		
Clean chimney		
check the tightening of the screws		
Check engine cap pellet hopper		
_____ Signature/stamp		

Company/SAT: _____		
Technical: _____		
Dates: _____		
Service hours of boiler: _____		
Quantity of pellets burned: _____		
Task	Check	Obs.
Clean burner		
Clean smoke circuit and turbulators		
Vacuum pellet tank sawdust		
Check pressure of the expansion vessel		
Check safety valve 3 bar		
Check the fluid on the hydraulic circuit		
Clean the smoke extractor		
Check and clean the inspection T		
Clean chimney		
check the tightening of the screws		
Check engine cap pellet hopper		
_____ Signature/stamp		

Company/SAT: _____		
Technical: _____		
Dates: _____		
Service hours of boiler: _____		
Quantity of pellets burned: _____		
Task	Check	Obs.
Clean burner		
Clean smoke circuit and turbulators		
Vacuum pellet tank sawdust		
Check pressure of the expansion vessel		
Check safety valve 3 bar		
Check the fluid on the hydraulic circuit		
Clean the smoke extractor		
Check and clean the inspection T		
Clean chimney		
check the tightening of the screws		
Check engine cap pellet hopper		
_____ Signature/stamp		

Company/SAT: _____		
Technical: _____		
Dates: _____		
Service hours of boiler: _____		
Quantity of pellets burned: _____		
Task	Check	Obs.
Clean burner		
Clean smoke circuit and turbulators		
Vacuum pellet tank sawdust		
Check pressure of the expansion vessel		
Check safety valve 3 bar		
Check the fluid on the hydraulic circuit		
Clean the smoke extractor		
Check and clean the inspection T		
Clean chimney		
check the tightening of the screws		
Check engine cap pellet hopper		
_____ Signature/stamp		

18. Maintenance Guide Level

ATENÇÃO

BEM-VINDO À SUA SALAMANDRA PELLET - AR / ÁGUA

Este é um guia rápido. Encontra mais informação no manual de instruções. Este guia não dispensa a leitura atenta do manual de instruções.

GUIA DE MANUTENÇÃO E LIMPEZA

Algumas das tarefas podem ser feitas por si, outras por um técnico*.

	SALAMANDRA		TÉCNICO	AR	ÁGUA	SEMANAL	800 kg**	ANUAL
	UTILIZADOR	DIÁRIO						
Limpar queimador		✓		●	●			
Estar turbinadores e resaca demulador		✓		●	●			
Limpar compartimento do alçapado				●	●	✓		
Limpar ossos de cruzes				●	●			
Limpar circuito de fumo e turbinadores				●	●		✓	✓
Aspirar serrim no interior da caixa de pellets				●	●		✓	✓
Verificar pressão ao vaso de expansão				●	●			
Verificar validade de segurança 3 bar				●	●			
Verificar fluido do circuito hidráulico				●	●			
Limpar extractor de fumos				●	●			✓
Verificar e limpar o T de inspeção				●	●			✓
Limpar c/termó				●	●			✓

* Sempre que mudar de tarefa não podes ser necessário alterar a cor do ícone. Se necessário chamar técnico. ** Dependendo do tamanho dos pellets. *** A cada 800kg de pellets quatro vezes. **** Para efectuar estas operações é necessário desmontar os respectivos componentes. Chamar técnico. Estas operações não estão abrangidas pela garantia.

1 **MANUAL**
 Leia o manual de instruções antes da primeira utilização.

2 **PELLETS***
 Coloque os pellets no depósito. Use sempre pellets norma EN 14975-2.

3 **START (STOP)**
 Para iniciar ou parar, pressione o botão On/Off durante 3 segundos.

4 **AVANÇADO**
 Para definições avançadas (avanzado) ver o manual de instruções.

5 **ALARME**
 Quando alarme soar, consulte a lista de alarmes e siga as instruções para ligar o equipamento.

6 **LISTA DE ALARMES**
 Para consultar a lista de alarmes, consulte o manual de instruções.

7 **ALARME* RESET**
 Como sinal de alarme a buzina soa quando o On/Off durante 10 seg. até ouvir o sinal sonoro.

8 **LIMPEZA**
 Seguir a lista de tarefas para limpeza. Para mais informações consulte o manual de instruções.

Figure 62 - Maintenance guide label

Note: The safety warnings sticker label is attached from factory to the unit's pellet lid, in the Portuguese language. Attached to the manual you will find other language versions of the sticker labels (Spanish, English, French and Italian). If necessary, remove the Portuguese language label and replace it with the label in your country's language.

19. Installation Diagrams

Simple connection only the central heating radiators

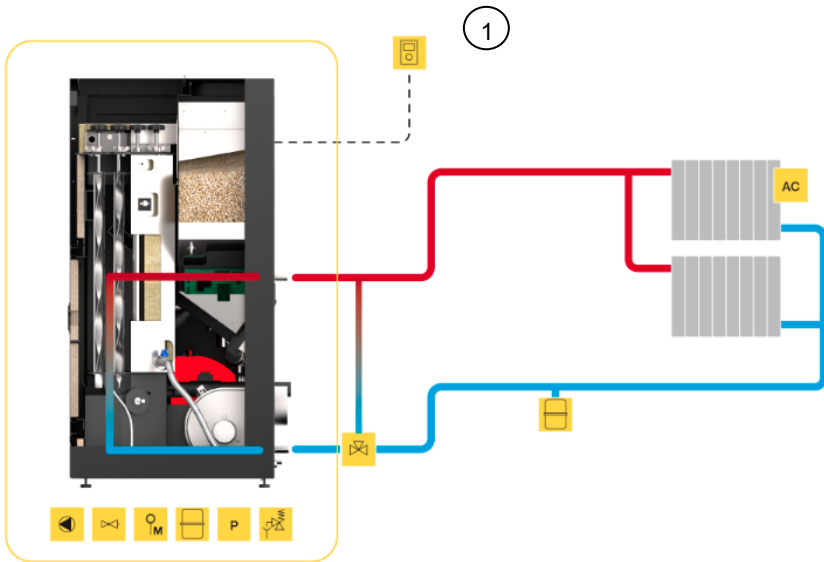


Figure 63 - Simple connection only the central heating radiators



The installation of an anti-condensation valve is recommended for Hidro 12.

Note:

- The chrono-thermostat should have 1 to 2 °C of hysteresis. 1
- Hydro independent "On" (water temperature-controlled regulation)
- Modulating pump "On"
- Water sensing inhibition "On"
- Alternative hydro shutdown "On"
- Pump "On" = 50 °C
- Pump "Off" = 50 °C

We can set / change according to the customer's discretion to another temperature.

Connection to central heating radiators and sanitary water combined with solar panel

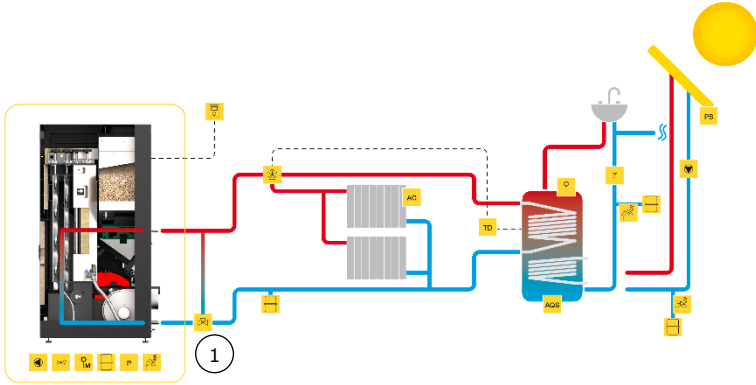



Figure 64 - Connection to central heating radiators and sanitary water combined with solar panel

①  The installation of an anti-condensation valve is recommended for Hidro 12.
Example: electrical connection of a thermostat (ambient air monitoring) of a differential thermostat connected to the deposit and three-way valve to a relay box.

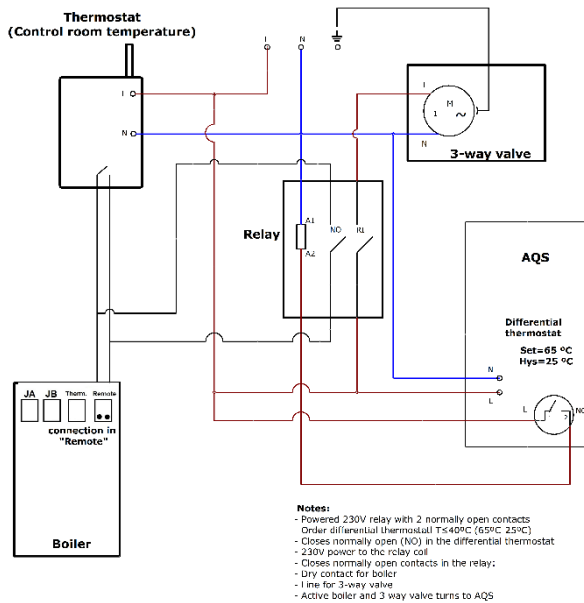


Figure 65 - Electrical connection of a thermostat (ambient air monitoring) of a differential thermostat connected to the deposit and three-way valve to a relay box

Connection to central heating radiators with another boiler support and sanitary water combined with solar panel

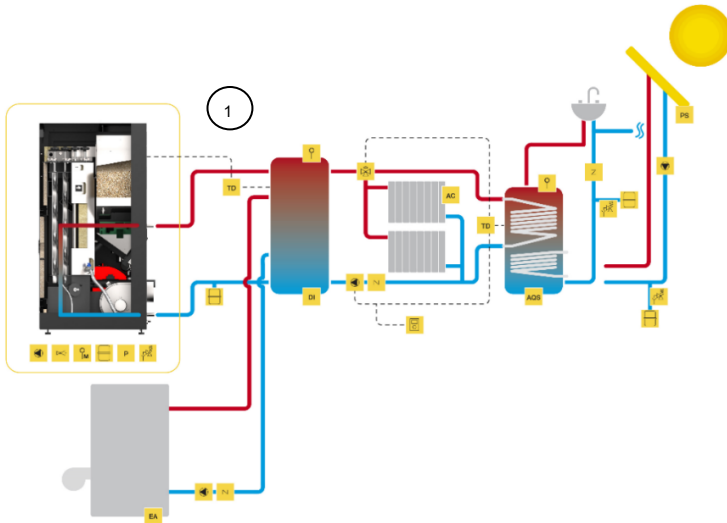


Figure 66 - Connection to central heating radiators with another boiler support and sanitary water combined with solar panel

Note:

- The differential thermostat must have a hysteresis of 15 to 25 °C. ①
- Hydro independent "Off" (water temperature-controlled regulation), put the boiler in "manual" mode and power level to "5"
- Modulating pump "On"
- Water sensing inhibition "On"
- Alternative hydro shutdown "On"
- Pump "On" = 50 °C
- Pump "Off" = same or thermostat temperature 1°C below the temperature differential thermostat.

When using the generator with differential thermostat the machine must be connected in the CONNECTION "Remote".

Calculation deposits of inertia: the boilers for pellets it's recommended that the buffer tank has 20l/kW.

NOTE: For Columbus electronics when connecting the stove to the inertia tank it is necessary to change the following parameters:

P77=04

A01=04

(Contact technical support if necessary)

Connecting underfloor heating in conjunction with another boiler support and sanitary water combined with solar panel

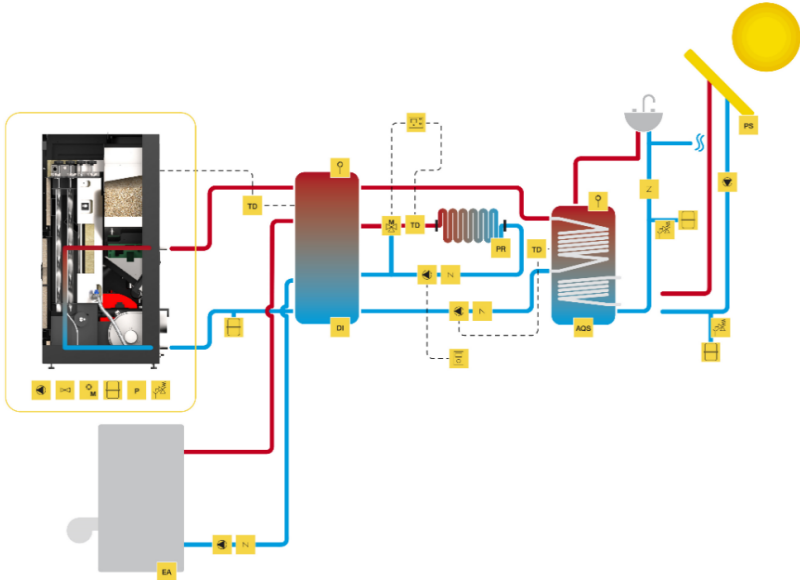


Figure 67 - Connecting underfloor heating in conjunction with another boiler support and sanitary water combined with solar panel

NOTE: For Columbus electronics when connecting the stove to the inertia tank it is necessary to change the following parameters:

P77=04

A01=04

(Contact technical support if necessary)

Symbology

EA	Equipamento de Apoio (gás, gasóleo)	Z	Válvula Anti-Retorno		Válvula Anti-Condensação
DI	Depósito de Inércia		Bomba Circulação		Válvula Segurança Térmica
AQS	Águas Quentes Sanitárias		Válvula 3 Vias Motorizada		Válvula Segurança Pressão
PS	Painel Solar		Purgador Automático		Controlador Piso Radiante
AC	Aquecimento Central		Purgador Manual		Termostato Ambiente
P	Sensor de Pressão		Vaso Expansão Fechado		Água Quente
TD	Termostato Diferencial		Válvula de Esvaziar		Água Fria
PR	Piso Radiante		Válvula Misturadora		Ligações Eléctricas

Figure 68 - Symbology

20. Electrical diagram of the Free-Standing Pellet Fire unit

20.1. Electrical diagram – Not applicable to Columbus electronics

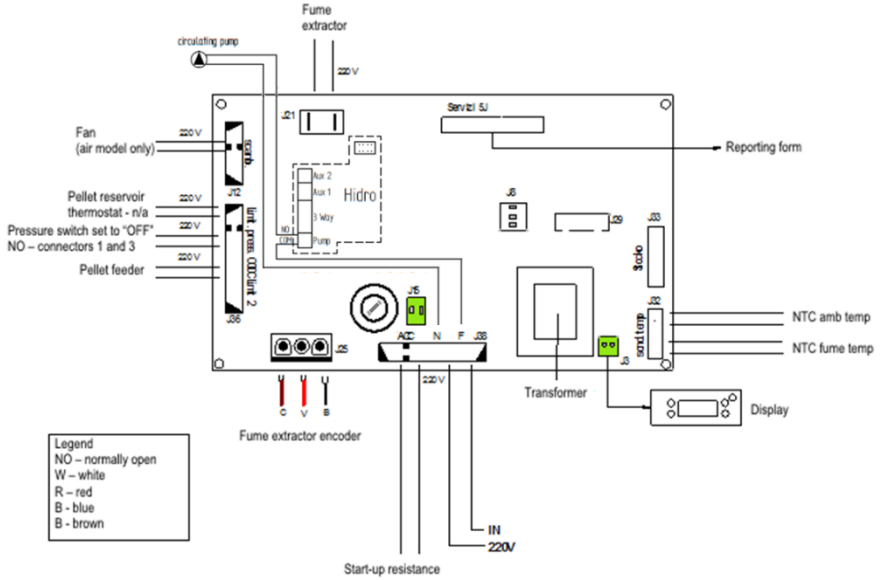


Figure 69 - Electrical diagram Hidro 12

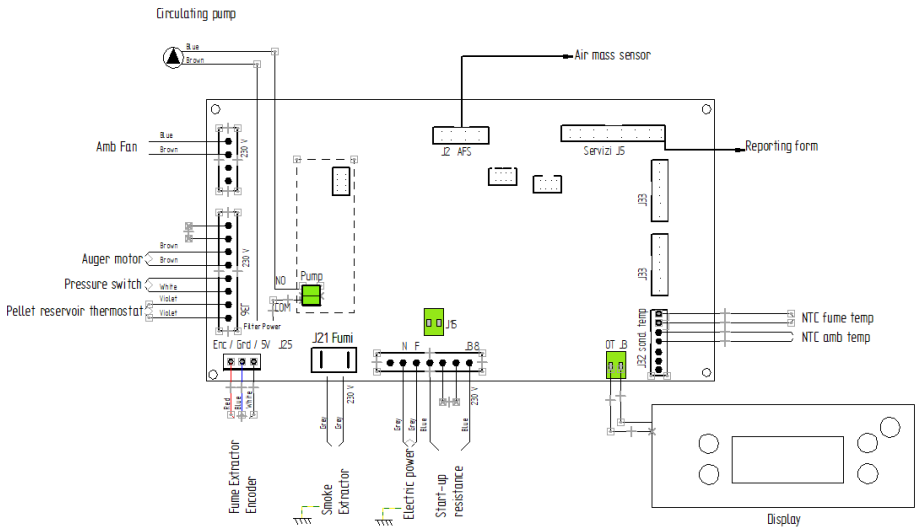


Figure 70 - Electrical diagram Hidro 17 and Hidro 23

20.2. Electrical diagram – Applicable to Columbus electronics

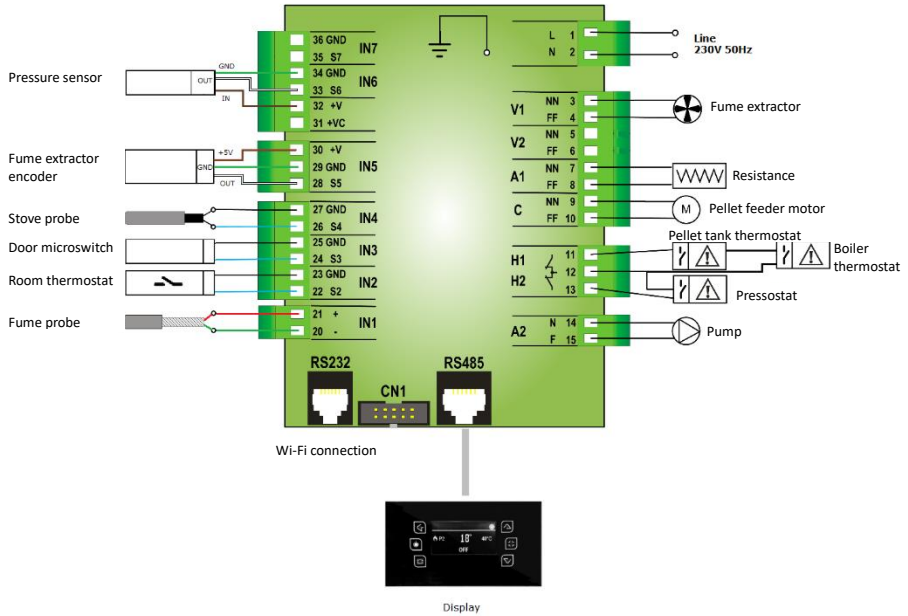


Figure 71 - Electrical diagram (Columbus electronics)

21. Hydraulic Pumps

21.1. Pump UPM3 FLEX AS 15-70 130mm

Performance graph for the circulating pump

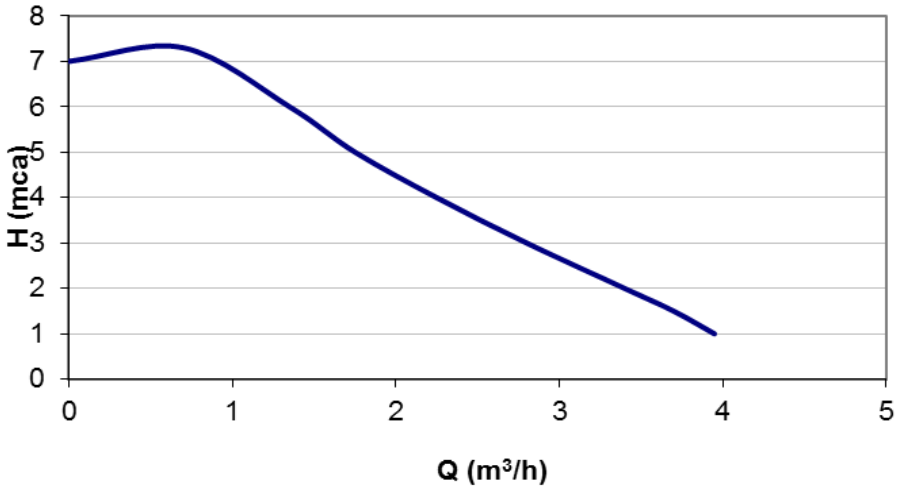


Figure 72 - Circulating pump performance graph

User interface

The user interface was designed with a single button, a red/green LED and four yellow LEDs.

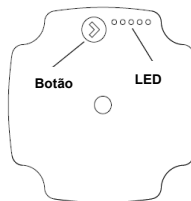


Figure 73 - User interface

When the pump is operating, the LED 1 is green. 4 yellow LEDs indicate the current performance of the pump, as shown in the following table.

Active LED	Performance (%)
LED Green	0 (Standby)
LED Green + 1 LED Yellow	0 - 25
LED Green + 2 LED Yellow	25 - 50
LED Green + 3 LED Yellow	50 - 75
LED Green + 4 LED Yellow	75 - 100

Table 8 - Performance of the pump

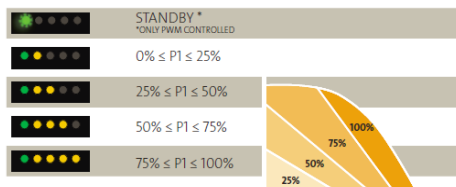


Figure 74 - Performance of the pump

Note: the pump is configured as standard at full capacity (75-100%).

Changing the setting of the pump

Can be chosen between the view of the performance of pump and the view of settings, just press the button once.

If you need to change the pump performance, you must press the button for 2 seconds (Figure 75), after this action the LEDs start blinking, then you must press the button until the desired setting (Table 9), after 10 seconds the display automatically switches to the view of performance with alteration saved.

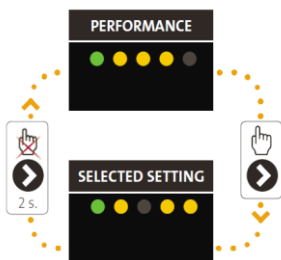


Figure 75 - Pump settings





Maximum manometric height (m)	Settings
2-4	
3-5	
4-6	
5-7	

Table 9 - Pump settings

Alarms

If the pump detects one or more errors, the LED 1 changes from green to red when the alarm is activated the yellow LED indicates the type of alarm (see Table 6), if we have several alarms at the same time, the yellow LED indicates the alarm with higher priority, the priority sequence is defined on table as follows:




Display	Priority	Alarm	Action
LED 1 red + LED 5 yellow 	1	Rotor is blocked	Wait or deblock the shaft
LED 1 red + LED 4 yellow 	2	Supply voltage too low	Control the supply voltage
LED 1 red + LED 3 yellow 	3	Electrical error	Control the supply voltage or replace the pump

Table 10 - Alarms

21.2. Pump Wilo 15-130/7-50

The Wilo 15-130/7 50 circulator pump consists of:

1. Pump housing with screwed connections
2. Glandless motor
3. Condensate drain openings (4x around circumference)
4. Housing screws

5. Control module
6. Rating plate
7. Operating button for pump adjustment
8. Run signal/fault signal LED
9. Display of selected control mode
10. Display of selected characteristic curve (I, II or III)

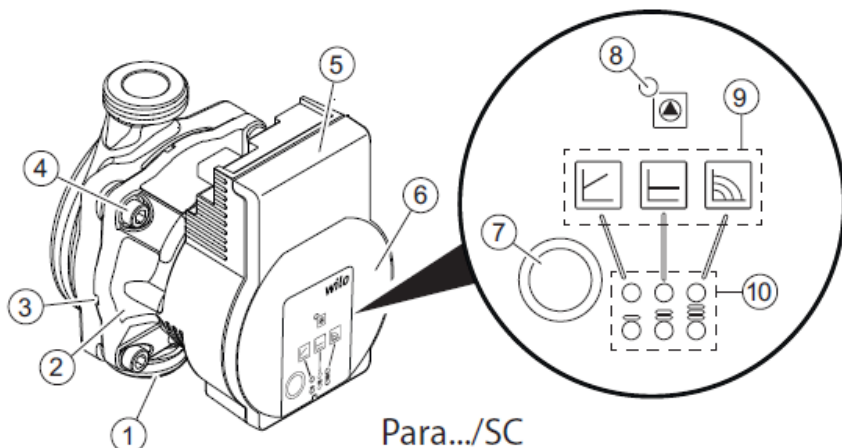


Figure 76 - Pump Wilo

Installing the pump

Observe the following points when installing the pump (Figure 77):

- Note the direction arrow on the pump housing (1).
- Install glandless motor (2) horizontally, without mechanical tension.
- Place gaskets in the screwed connections.
- Screw on threaded pipe unions.
- Use an open-end wrench to secure the pump against twisting and screw tightly to piping.
- Re-mount the thermal insulation shell if required.

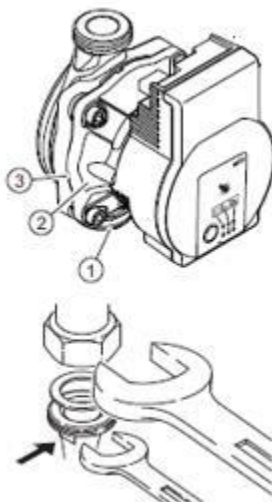


Figure 77 - Installing the pump

⚠ WARNING!

- Insufficient heat dissipation and condensation water may damage the control module and the glandless motor.
- Do not thermally insulate the glandless motor (2).
- Ensure all condensate drain openings (3) are kept free.

Indicator lights

The user interface is designed with the following LED indicators and control keys.





Active LED	Description
	<ul style="list-style-type: none"> - LED is lit up in green in normal operation. - LED lights up/flashs in case of a fault.
	<ul style="list-style-type: none"> - Display of selected control mode ΔP-v, Δp-c and constant speed (the only mode available in Solzaima electronics).
	<ul style="list-style-type: none"> - Display of selected pump curve (I, II, III) within the control mode.
	<ul style="list-style-type: none"> - LED indicator combinations during the pump venting function, manual restart and key lock.

Table 11 - Indicator lights

Operating button

Press

- Select control mode.
- Select pump curve (I, II e III - Figure 82) within the control mode.

Press and hold

- Activate the pump venting function (press for 3 seconds).
- Activate manual restart (press for 5 seconds).

- Lock/unlock button (press for 8 seconds).

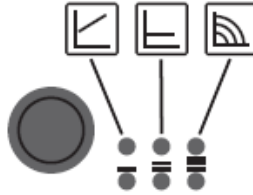


Figure 78 - Operating button

Setting the control mode

Select control mode

The LED selection of control modes and corresponding pump curves takes place in clockwise succession.

Press the operating button briefly (approx. 1 second). LEDs display the set control mode and pump curve.

In the Solzaima's electronics, it is only possible to select the **green** diagram corresponding to constant speed, but 3 different speeds can be chosen.

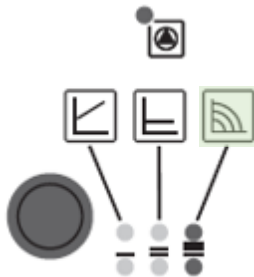


Figure 79 - Control mode




LED display	Control mode	Pump curve
	Constant speed.	I
	Constant speed.	II
	Constant speed.	III

Table 12 - Control mode

Functions

Venting

If the pump does not vent automatically:

- Activate the pump venting function via the operating button, press and hold for 3 seconds, then release.
- The pump venting function is initiated and lasts 10 minutes.
- The top and bottom LED rows flash in turn at 1 second intervals.
- To cancel, press and hold the operating button for 3 seconds.

Manual restart

The pump attempts an automatic restart upon detecting a blockage.

If the pump does not restart automatically:

- Activate manual restart via the operating button: press and hold for 5 seconds, then release.
- The restart function is initiated, and lasts max. 10 minutes.
- The LEDs flash in succession clockwise.
- To cancel, press and hold the operating button for 5 seconds.



Figure 80 - Manual restart

⚠ WARNING! After the restart, the LED display shows the previously set values of the pump.

Lock/unlock the button

- To activate the key lock, press and hold the operating button for 8 seconds until the LEDs for the selected setting briefly flash, then release.
- LEDs flash constantly at 1-second intervals.
- The key lock is activated: pump settings can no longer be changed.
- The key lock is deactivated in the same manner as it is activated.

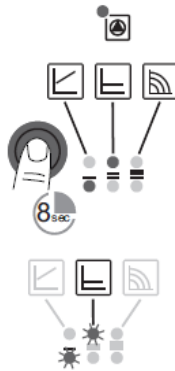


Figure 81 - Lock/unlock the button

Activating factory setting

- The factory setting is activated by pressing and holding the operating button whilst switching off the pump.
- Press and hold the operating button for at least 4 seconds.
- All LEDs flash for 1 second.
- The LEDs for the last setting flash for 1 second.
- When the pump is switched on again, the pump runs using the factory settings (delivery condition).

Faults, Causes and Solutions

The following tables show some of the problems of installing Wilo pumps.

Faults	Causes	Solutions
Pump is not running although the power supply is switched on	No voltage supply at pump	Rectify the power interruption
Noisy pump	Cavitation due to insufficient suction pressure	Increase the system pressure within the permissible range Check the delivery head and set it to a lower head if necessary
Building does not warm up	Thermal output of the heating surfaces is too low	Increase setpoint

Table 13 - List of faults and solutions




LED	Faults	Causes	Solutions
Lights up red 	Blocking	Rotor blocked	Activate manual restart or contact customer service
	Contacting/winding	Winding defective	
Flashes red 	Under/overvoltage	Power supply too low/high on mains side	Check mains voltage and operating conditions, and request customer service
	Excessive module temperature	Module interior too warm	
	Short-circuit	Motor current too high	
Flashes red/green 	Generator operation	Water is flowing through the pump hydraulics, but there is no mains voltage at the pump	Check the mains voltage, water quantity/pressure and the ambient conditions
	Dry run	Air in the pump	
	Overload	Sluggish motor, pump is operated outside of its specifications (e.g., high module temperature). The speed is lower than during normal operation.	

Table 14 - List of faults and solutions

Reading performance curve

For a given speed, the pump can overcome a given pressure drop, for a given flow:

- The pressure drop (or manometric height) is identified on the ordinate axis, with the units in metres (m) - It depends on the installation.
- The flow rate is identified on the x-axis, with the units in cubic metres per hour (m^3/h)
- Depends on the power to be conditioned.
- Constant velocity curves are present in the graph, identified in I, II and III.
- The installer must set the required curve from the lowest to the highest speed by means of the required flow rate and the head loss of the installation.
- The pumps run at the highest speed in the factory.

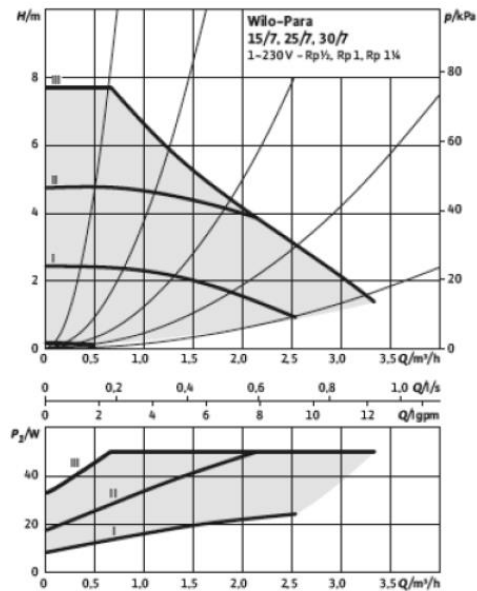


Figure 82 - Pump performance - Constant speeds I, II and III

22. Life Cycle of a Free-Standing Fire Unit

Approximately 90% of the materials used to manufacture these units are recyclable, contributing towards a reduced environmental impact and a more sustainable planet. End-of-life units should be processed by licensed waste operators. We recommend contacting your local council to ensure the unit is collected and handled pursuant to any legal requirements.

23. Sustainability

Solzaima designs and manufactures biomass solutions and biomass-fuelled equipment as a primary energy source. This is our contribution for the sustainability of our planet – an economically viable and environmentally-friendly alternative, following environmental best management practices to ensure an efficient carbon cycle management.

Solzaima makes all efforts to learn and to know the national forest park while efficiently responding to energy demands, taking permanent care to maintain its biodiversity and natural wealth that are essential for the quality of life on our planet.

SOLZAIMA is a member of the Portuguese **Sociedade Ponto Verde**, which manages packaging waste from products that the company places on the market, so you can take the packaging waste from your unit, such as plastic and cardboard, to your nearest recycling point.

SOLZAIMA is a member of **Amb3E**, the entity responsible for collecting waste electrical and electronic equipment (WEEE). Thus, end-of-life units with forced ventilation systems should be transported to an appropriate WEEE-processing location. When you disassemble your equipment, you can take its electrical components to your nearest WEEE collection point.



24. Warranty

24.1. Model-specific conditions

This model requires that the unit is subject to start-up for the warranty to be activated. The start-up service can only be performed by technical services authorised by the manufacturer. This is mandatory before the unit reaches 100 service hours. The final user is responsible for any expenses related to the start-up service.

To activate the warranty, it is necessary to send the start-up form duly filled to the following email: apoio.cliente@solzaima.pt.

24.2. Warranty general conditions

1. Social name and address of the producer and Object

Solzaima, S.A.

Rua dos Outarelos, 111

3750-362 Belazaima do Chão

This document does not substantiate the provision by Solzaima S.A. of a voluntary warranty on its produced and marketed products (from now on mentioned as "Product (s)"), but rather a guide, intended to be enlightening for the effective activation of the legal warranty that benefits consumers (from now on mentioned as "Warranty"). This document does not affect the legal rights of warranty, emerging from the purchase agreement whose purpose is the Product(s).

2. Product identification on which rests the warranty

The activation of the warranty presupposes prior and correct identification of the product object towards Solzaima, SA, being promoted by providing the Product 's packing data indicated in the purchase invoice or in the product characteristics plate (model and serial number).

3. Product warranty terms

3.1 Solzaima, S.A., responds to the Buyer, for the lack of conformity of the Product with the respective contract of sale, within the following periods:

3.1.1 A period of 24 months from the date of delivery of the good, in the case of domestic use of the product, save the provisions of the following number regarding the intensive use;

3.1.2 A term of 6 months from the date of delivery of the goods, in the case of professional, or industrial, or intensive use of the products - Solzaima means

by professional, industrial or intensive use of all products installed in industrial spaces, commercial, or whose use exceeds 1500 hours per calendar year;

3.2 A functional test of the product must be performed before finishing the installation (plaster, masonry, coatings, paintings, among others);

3.3 No equipment can be replaced after the 1st Burn without the express authorization of the producer;

3.4 Any product must be repaired on the site of installation without causing serious inconvenience to the parties, save, if this proves impossible, or disproportionate;

3.5 In order to exercise its rights, and provided that the term indicated in 3.1 is not exceeded, the Buyer must report in writing to Solzaima, S.A., the lack of conformity of the Product within a maximum period of:

3.5.1 60 (sixty) days after the date on which it has detected it in the case of domestic use of the product;

3.5.2 Thirty (30) days from the date of its detection, in the case of professional use of the Product.

3.6 In the pellet range equipments, the commissioning service is required to activate the warranty. It must be registered up to 3 months after the date of invoice, or, 100 hours of work of the product (whichever occurs first);

3.7 During the Warranty period referred to in paragraph 3.1 (and for this to remain valid), repairs to the Product must be performed exclusively by the Official Technical Services of the Brand. All services provided under this Guarantee will be performed Monday through Friday within the working time and calendar legally established in each region.

3.8 All requests for assistance must be submitted to the Solzaima, S.A. Customer support service, by means of a proper form present on the Website www.solzaima.co.uk, or, e-mail: support.cliente@solzaima.pt. At the time of the technical assistance to the Product, the Buyer must present, as proof of the Product Warranty, the purchase invoice of the same or another document demonstrating its

acquisition. In any case, the document proving the acquisition of the Product must contain the identification of the Product (as mentioned in point 2 above) and its date of acquisition. Alternatively, and in order to validate the Product Warranty, the PSR - document certifying the commissioning of the machine (when applicable)).

3.9 The Product will have to be installed by a qualified professional for the purpose, in accordance with the regulations in force in each geographical area, for the installation of these Products and complying with all the regulations in force, especially regarding chimneys, as well as other applicable regulations for aspects such as water supply, electricity and / or other related to the equipment or sector and as described in the instruction manual.

A product installation that does not conform to the manufacturer's specifications and / or does not comply with the legal regulations on this subject will not give rise to the application of this Warranty. Whenever a product is installed outdoors, it must be protected against weather effects such as rain and wind. In these cases, it may be necessary to protect the appliance by means of a cabinet, or a properly ventilated protective case. Appliances should not be installed in places that contain chemicals in their atmosphere, in saline or high humidity environments, as mixing them with air may produce rapid corrosion in the combustion chamber. In this type of environment, it is especially recommended that the appliance be protected with anti-corrosion products for this purpose, especially during times of operation. As a suggestion it is indicated the application of graphite greases indicated for high temperatures with function of lubrication and anti-corrosion protection.

3.10 In equipment belonging to the pellet family, in addition to the daily and weekly maintenance contained in the instruction manual, it is also obligatory to carry out the cleaning inside and in the respective chimney for the evacuation of fumes. These tasks should be carried out every 600-800 kg of pellets consumed, in the case of stoves (air and water) and compact boilers, and every 2000-3000 kg of pellets consumed in the case of automatic boilers. In the event that these quantities are not consumed, at least one systematic preventive maintenance must be carried out annually.

3.11 It is the Buyer's responsibility to ensure that periodic maintenance is carried out, as indicated in the instruction and handling manuals accompanying the Product. Whenever requested, it must be proved by submitting the technical report of the entity responsible for it, or alternatively by registering them in the instruction manual in the dedicated section.

3.12 In order to avoid damage to the equipment caused by overpressure, safety elements such as pressure relief valves and / or thermal discharge valves, if applicable, as well as an expansion vessel fitted to the installation, shall be ensured at the time of installation and its correct functioning must be ensured . It should be noted that: the valves referenced must have a value equal to or less than the pressure supported by the equipment; there shall be no cut-off valve between the equipment and its safety valve; provision should be made for a systematic preventive maintenance plan to attest to the correct functioning of the said safety features; irrespective of the type of appliance, all safety valves shall be channelled to drained sewage to prevent damage to the dwelling by water discharges. Product Warranty does not include damages caused by non-channeling of water discharged by said valve.

3.13 In order to avoid damage to the equipment and attached pipes by galvanic corrosion, it is advisable to use dielectric separators in the connection of the equipment to metal pipes whose characteristics of the materials applied to this type of corrosion. Product Warranty does not include damages caused by non-use of such dielectric separators.

3.14 The water or thermofluid used in the heating system (hydro stoves, boilers, central heating stoves, among others) must comply with the legal requirements in force, as well as guarantee the following physical and chemical characteristics: absence of solid particles in suspension; low level of conductivity; residual hardness of 5 to 7 degrees; neutral pH, close to 7; low concentration of chlorides and iron; and absence of air inlets by depression or others. In case the installation enhances automatic water make-up, it should consider upstream a preventive treatment system composed of filtration, decalcification and preventive dosing of polyphosphates (scale and corrosion), as well as a degassing step, if necessary. If in any circumstance any of these indicators show values that are not recommended, the Warranty will cease to have effect. It is also compulsory to place a non-return valve between the automatic filling valve and the mains water supply, and that said supply always has constant pressure, even with a lack of electricity, not depending on lift pumps, autoclaves, or others.

3.15 Except as expressly provided by law, a warranty intervention does not renew the warranty period of the Product. The rights arising from the Warranty are not transferable to the purchaser of the Product.

3.16 The equipment must be installed in accessible places and without risk to the technician. The means necessary for access to them shall be made available by the Buyer, and the Buyer shall be responsible for any charges arising therefrom.

3.17 The Warranty is valid for the Products and equipment sold by Solzaima SA solely and exclusively within the geographical and territorial zone of the country where the Product was sold by Solzaima.

4. Circumstances that exclude the application of the Warranty

Excluded from the Warranty, being the total cost of the repair borne by the Buyer, the following cases:

4.1. Products with more than 2000 operating hours;

4.2. Refurbished and resold products.

4.3. Maintenance operations, Product settings, commissioning, cleaning, elimination of errors or anomalies that are not related to deficiencies of equipment components and replacement of the batteries

4.4. Components in direct contact with fire such as: vermiculite supports, deflector or protective plates, vermiculite, sealing lanyards, burners, ash drawers, wood chips, smoke registers, ash grates, whose wear is directly related to the conditions of use. Degradation of the paint, as well as corrosion due to degradation of the paint, due to overloading of fuel, use of an open drawer or excessive drainage of the installation chimney (the chimney must respect the drawing recommended in the Product Technical Data Sheet). Glass breakage due to improper handling or other reason not related to Product deficiency. In the pellet family, the ignitors are aware part, so they are only guaranteed for 6 months, or 1000 ignitions (whichever comes first);

4.5. Wear considered components, such as bearings and bushes;

4.6. Deficiencies of components external to the Product that may affect its correct functioning, as well as material or other damages (e.g. tiles, roofing, waterproofing, pipes, or personal injury) caused by improper use of materials in the installation or by non-execution of the product installation in accordance with the rules for the

installation, applicable regulations or rules of good art, in particular when the application of suitable piping to the temperature in use, expansion vessels, non-return valves, safety valves , anti-condensation valves, among others;

4.7. Products whose operation has been affected by failures or deficiencies of external components or by poor sizing;

4.8. Defects caused by the use of accessories or replacement components other than those determined by Solzaima, S.A.;

4.9. Defects arising from non-compliance with the installation, use and operation instructions or applications not conforming to the intended use of the Product, or from abnormal climatic factors, unusual operating conditions, overload or maintenance or cleaning performed improperly;

4.10. The Products that have been modified or manipulated by people outside the Official Technical Services of the brand and consequently without the explicit authorization of Solzaima, SA.;

4.11. Damage caused by external agents (rodents, birds, spiders, etc.), atmospheric and / or geological phenomena (earthquakes, storms, frost, hailstorms, thunderstorms, etc.), humid or saline aggressive environments such as proximity of the sea or river, as well as those derived from excessive water pressure, inadequate power supply (voltage with variations greater than 10%, with a nominal value of 230V, or, neutral voltage greater than 5V, or absence of earth protection); pressure or supply of inadequate circuits, acts of vandalism, urban confrontation and armed conflict of any kind, as well as derivatives;

4.12. Failure to use the fuel recommended by the manufacturer is a condition of exclusion from the Warranty.;

Explanatory note: In the case of pellet appliances the used fuel must be certified by EN 14961-2 grade A1. Also, before buying large quantity you should test the fuel to see how it behaves. In wood equipment, this moisture content must be of less than 20%.

4.13. The appearance of condensation, either by poor installation or by the use of non-virgin fuels (such as pallets or wood impregnated with paints or varnishes, salt or other components), which may contribute to the accelerated degradation of equipment and especially to your combustion chamber;

4.14. All Products, Components or damaged components in transportation or installation;

4.15. Cleaning operations carried out on the appliance or its components due to condensation, fuel quality, bad settings or other circumstances of the installation location. Also excluded from the Warranty are interventions for the descaling of the Product (the removal of limestone or other materials deposited inside the apparatus and produced by the quality of the water supply). Also excluded from this warranty are air bleeding interventions of the circuit or unblocking of circulating pumps.

4.16. The installation of the equipment supplied by Solzaima, S.A. should contemplate the possibility of their easy removal, as well as points of access to the mechanical, hydraulic and electronic components of the equipment and the installation. When the installation does not allow immediate and safe access to the equipment, the additional cost of access and security will always be borne by the Buyer. The cost of disassembling and assembling boxes of plasterboard or masonry walls, insulation or other elements such as chimneys and hydraulic connections that prevent free access to the Product (if the Product is installed inside a carton of plasterboard, masonry or other dedicated space must comply with the dimensions and characteristics indicated in the instruction manual and use accompanying the appliance).

4.17. Interventions of information or clarification at home about the use of its heating system, programming and / or reprogramming of control and regulating elements, such as thermostats, regulators, programmers, etc.;

4.18. Interventions for the adjustment of fuel recipes in pellet devices, cleaning, detection of water leaks in pipes external to the apparatus, damage caused due to the need to clean the gas evacuation machinery or flues;

4.19. Urgency interventions not included in the provision of Warranty i.e., weekend

and holiday interventions because they are special interventions not included in the Guarantee coverage and which therefore have an additional cost, will be carried out exclusively on request expressed by the Buyer and upon the availability of the Producer.

5. Warranty Inclusion

Solzaima, S.A. will correct without any charge to the Buyer the defects covered by the Warranty through the repair of the Product. The replaced Products or Components shall become the property of Solzaima, S.A.

6. Responsibility of Solzaima, S.A

Notwithstanding legally established, Solzaima, S.A., liability in respect of warranty is limited to that established in the present warranty conditions.

7. Cost of Services performed outside the scope of the warranty

The interventions carried out outside the scope of the warranty are subject to the application of the current tariff.

8. Warranty Services performed out of scope Warranty

The interventions carried out outside the scope of the Warranty and carried out by the official technical assistance service of Solzaima have a 6-month guarantee.

9. Warranty Spare Parts provided by Solzaima

The Parts supplied by Solzaima, in the scope of the commercial sale of spare parts, that is, not incorporated in the equipment, do not have warranty.

10. Replaced Parts under the of Scope Technical Service

From the moment they are removed from the equipment, the Parts used are considered as waste. Solzaima as a producer of waste in the scope of its activity is obliged by the legislation in force to deliver them to a licensed entity that performs the proper waste management operations under the law and therefore is prevented from giving them another destination, whatever. Therefore, the customer will be able to see the used parts resulting from the assistance, but cannot keep them in their possession.

11. Administrative expenses

In the case of invoices for services rendered, they are not processed in any stipulated

period with default interest at the maximum legal rate in force.

12. Competent court

For the resolution of any dispute arising from the purchase and sale agreement having as object the products covered by the warranty, the contracting parties attribute exclusive jurisdiction to the courts of the district of Águeda, with express waiver of any other.

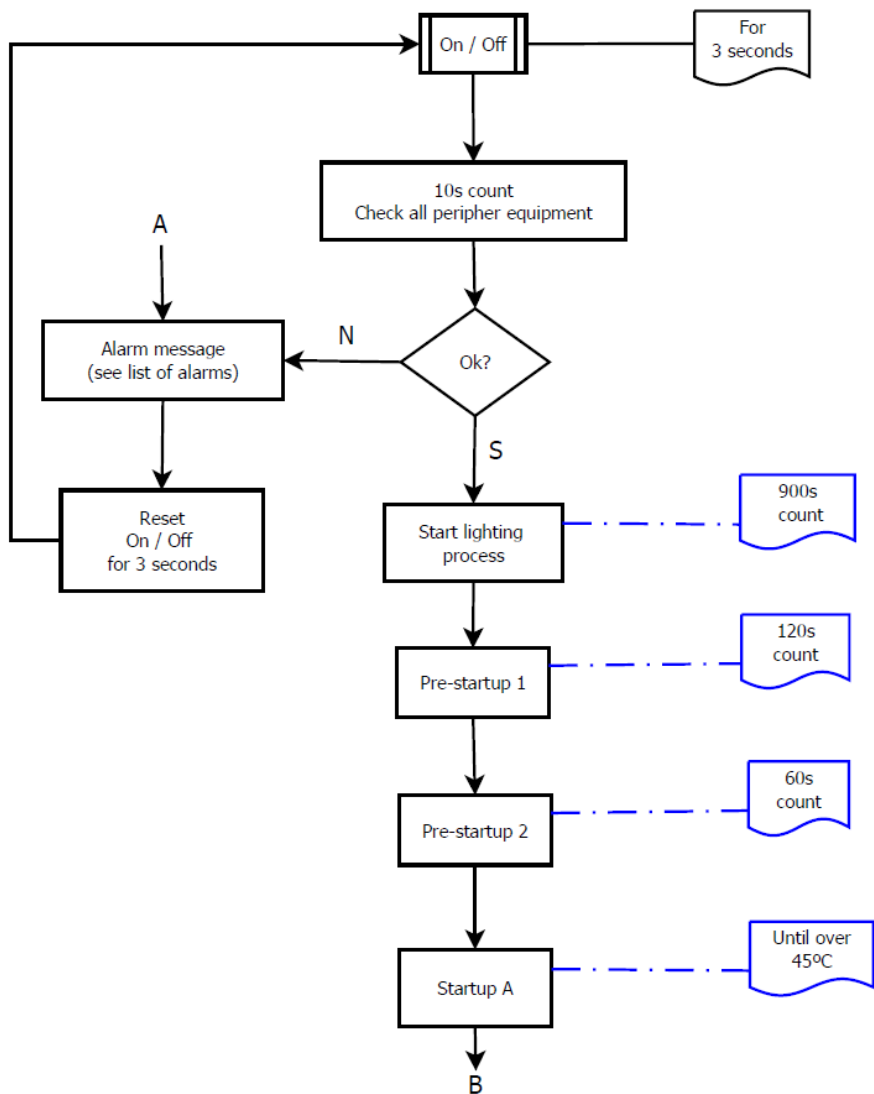
25. Annexes

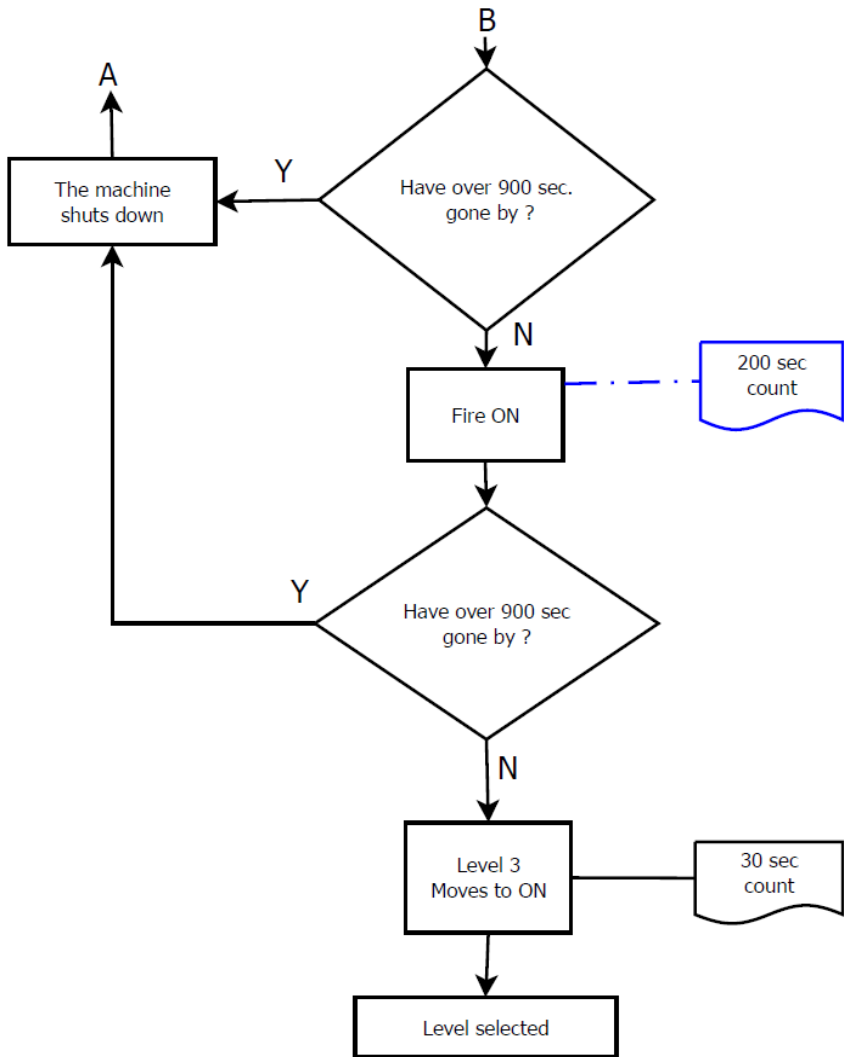
25.1. Timer weekly programming (Not applicable to Columbus electronics)

Prog No.	Days	Daily programming																							
		0	1	2	3	4	5	6	7	8	9	10	11	12	13	14	15	16	17	18	19	20	21	22	23
P01	Mon-Fri																								
	Sat-Sun																								
P02	Mon-Fri																								
	Sat-Sun																								
P03	Mon-Fri																								
	Sat-Sun																								
P04	Mon-Fri																								
	Sat-Sun																								
P05	Mon-Fri																								
	Sat-Sun																								
P06	Mon-Fri																								
	Sat-Sun																								
P07	Mon-Fri																								
	Sat-Sun																								
P08	Mon-Fri																								
	Sat-Sun																								
P09	Mon-Fri																								
	Sat-Sun																								
P10	Fri																								
	Sat-Sun																								

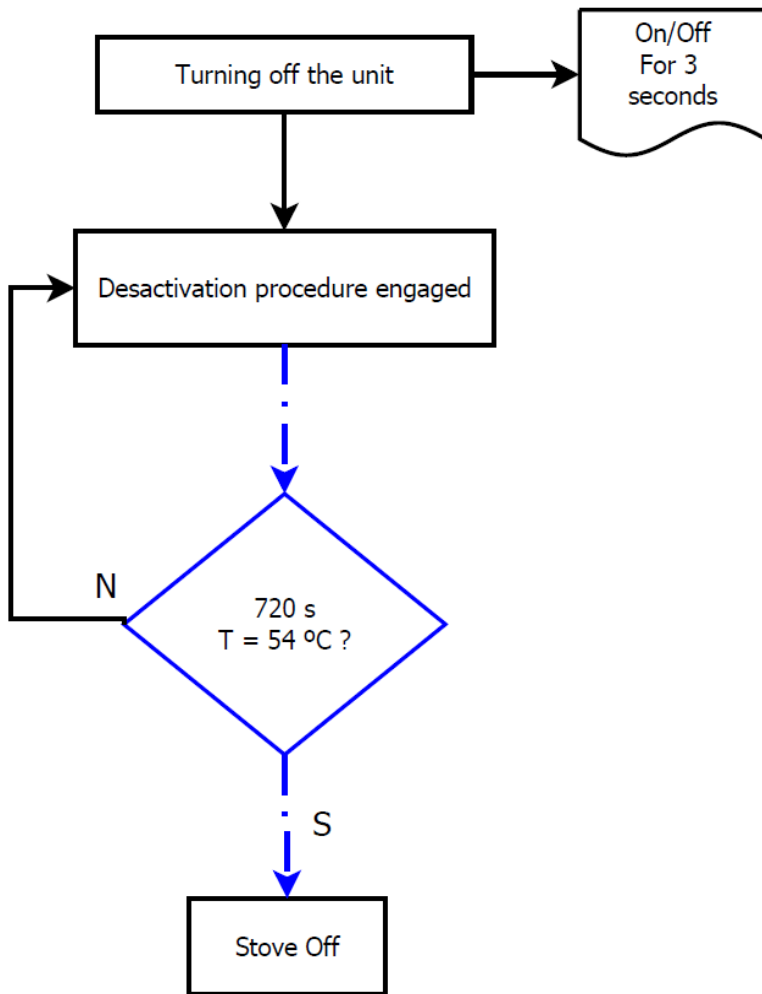
25.2. Flow chart Hidro 12

• Flow chart 1 – Lighting





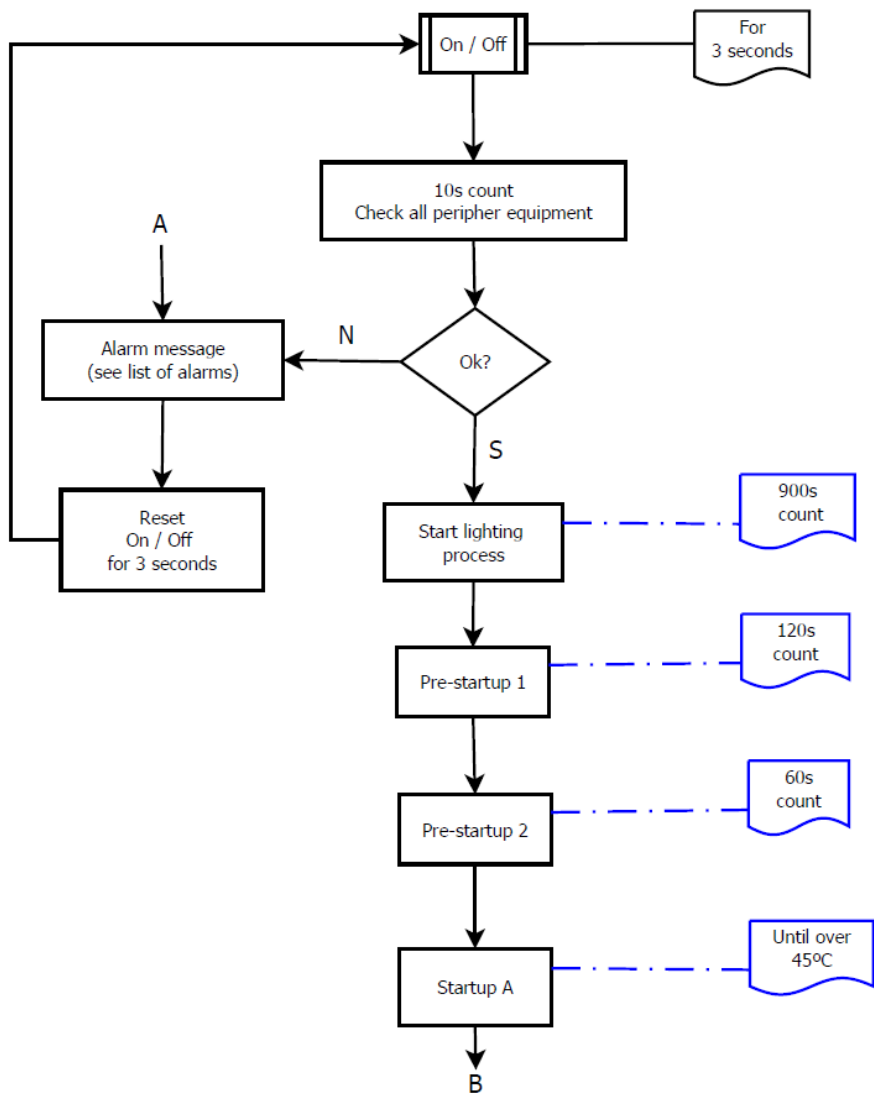
• Flow chart 2 – Disabling

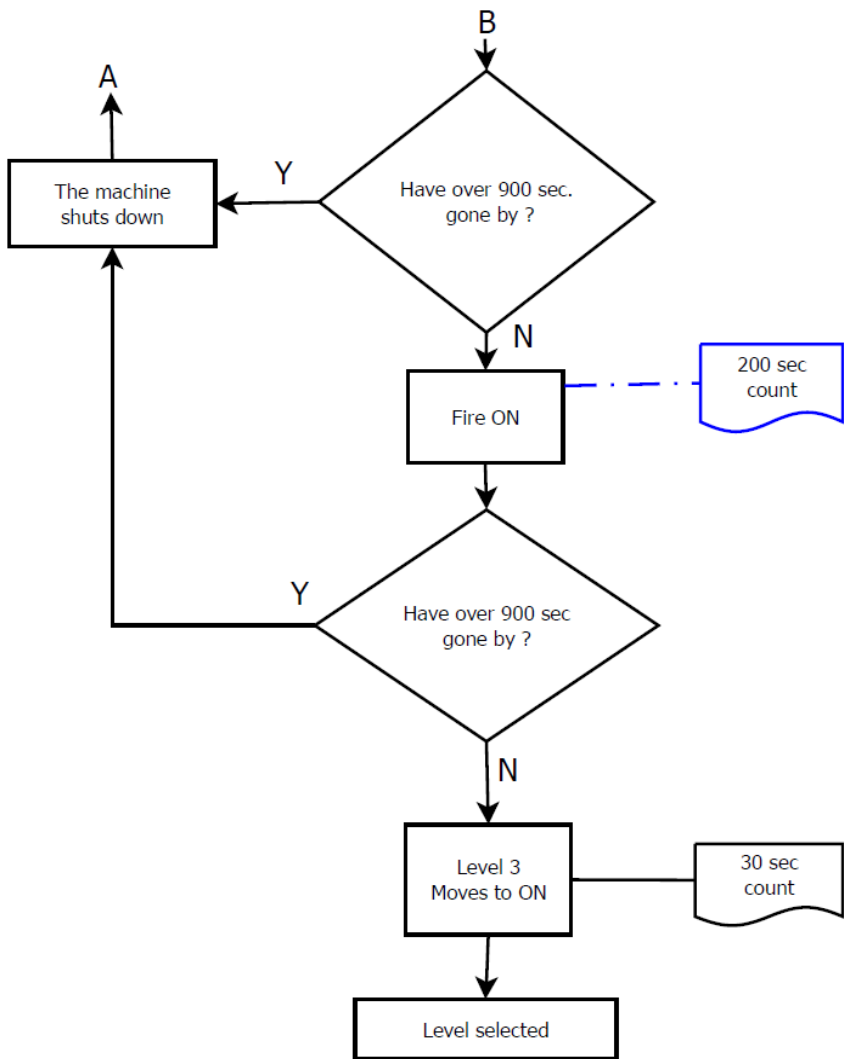


Note: The circulator pump off below 40 °C water temperature.

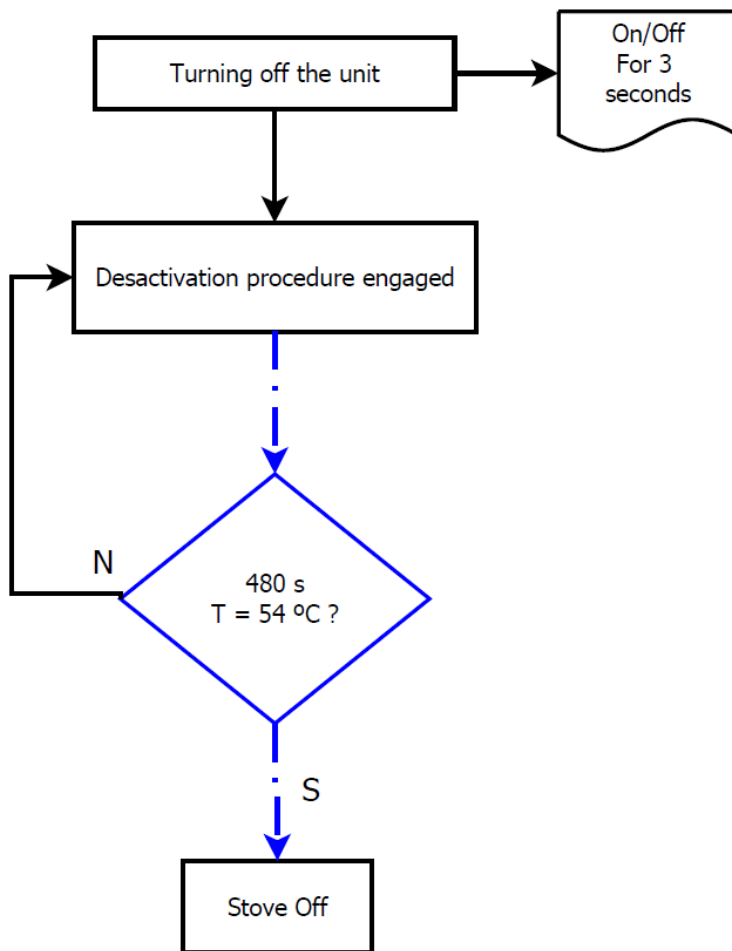
25.3. Flow chart Hidro 17 and Hidro 23

• Flow chart 1 – Lighting





• Flow chart 2 – Disabling



Note: The circulator pump off below 40 °C water temperature.

25.4. Statement of Performance

DECLARAÇÃO DE DESEMPENHO | DECLARACIÓN PRESTACIONES | DECLARATION OF PERFORMANCE | DÉCLARATION DE PERFORMANCE | DICHIARAZIONE DELLE PRESTAZIONI

Nº DD-070

1. Código de identificação único do produto-tipo | Código de identificación único del tipo de producto | Unique identification code of the product type | Le code d'identification unique du type de produit | Codice unico di identificazione del tipo di prodotto

HIDRO 12 kW – EAN 05600990464995

HIDRO 12 kW PORTA EM VIDRO – EAN 05600990465008

2. Número do tipo, lote ou série do produto | Número de tipo, lote o serie del producto | Number of type, batch or serial product | Nombre de type, de lot ou de série du produit | Numero di tipo, di lotto, di serie del prodotto

3. Utilização prevista | Uso previsto | Intended use | Utilisation prévue | Destinazione d'uso

AQUECIMENTO DE EDIFÍCIOS DE HABITAÇÃO COM POSSIBILIDADE DE FORNECIMENTO DE ÁGUA QUENTE | CALFECCIÓN DE EDIFÍCIOS RESIDENCIALES COM POSIBILIDAD DE SUMINISTRO DE AGUA CALIENTE | HEATING OF RESIDENTIAL BUILDINGS WITH POSSIBILITY OF HOT WATER SUPPLY | CHAUFFAGE DE BATIMENTS RESIDENTIELS AVEC LA POSSIBILITÉ DE L'APPROVISIONNEMENT EN EAU CHAUDE | RISCALDAMENTO DEGLI EDIFICI RESIDENZIALI CON POSSIBILITÀ DI ACQUA CALDA

4. Nome, designação comercial registada e endereço de contacto do fabricante | Nombre, marca registrada y la dirección de contacto de lo fabricante | Name, registered trade name and contact address of the manufacturer | Nom, marque déposée et l'adresse de contact du fabricant | Nome, denominazione commerciale registrata e Indirizzo del costruttore

SOLZAIMA, SA

RUA DA COVA DA AREIA (E.M. 605) 695

3750-071 AGUADA DE CIMA – ÁGUEDA – PORTUGAL

5. Sistema de avaliação e verificação da regularidade do desempenho do produto | Sistema de evaluación y verificación de constancia de las prestaciones del producto | System of assessment and verification of constancy of the product | Système d'évaluation et de vérification de la Constance des performances du produit | Sistema di valutazione e verifica della costanza della prestazione del prodotto

SISTEMA 3

6. Norma Harmonizada | Estandár armonizado | Harmonized standard | Norme harmonisée | Standard armonizzata

EN 14785

7. Nome e número de identificação do organismo notificado | Nombre y número de identificación del organismo notificado | Name and identification number of the notified body | Nom et numéro d'identification de l'organisme notifié | Nome e numero di identificazione dell'organismo notificato

CEIS

NB-1722

8. Relatório de ensaio | Informe de la prueba | Test report | Rapport d'essai | Rapporto di prova

CEE-0257/19-1 RV1

9. Desempenho declarado | Desempeño declarado | Declared performance | Performance déclarée | Dichiarazione di prestazione

<p>Características essenciais Características esenciales Essencial characteristics Caratteristiche essenziali Caractéristiques essentielles Caratteristiche essenziali</p>	<p>Desempenho Desempeño Performance Prestazione</p>	<p>Especificações técnicas harmonizadas Especificaciones técnicas armonizadas Harmonized technical specifications Specificazioni tecniche armonizzate Spécifications techniques harmonisées Specifiche tecniche armonizzate</p>
<p>Segurança contra incêndio Seguridad contra incendios Fire safety Sécurité incendie Sicurezza antincendio</p>	<p>OK. De acordo com relatório de ensaio De acuerdo com informe de la prueba According to the test report Selons le rapport d'essai Secondo i rapporto di prova CEE-0257/19-1 Rv1</p>	<p>De acordo com os requisitos De acuerdo con los requisitos According to the requirements Selons les exigences Secondo i requisiti 4.2, 4.3, 4.7, 4.8, 4.10, 4.11, 5.1, 5.3, 5.4, 5.5, 5.8 (EN14785)</p>
<p>Emissão de produtos da combustão La emisión de productos de combustión Emission of combustion products Emission des produits de combustion Emissione dei prodotti di combustione</p>	<p>OK. Caudal térmico nominal Caudal térmico nominale Nominal heat output Le débit calorifique nominal Nominal heat output Flux thermique nominal - CO:0,0136%</p> <p>OK. Caudal térmico reduzido Flujo térmico reducido Reduced thermal flow Flux thermique réduit Flusso termico ridotto - CO:0,0256%</p>	<p>Caudal térmico nominal Caudal térmico nominale Nominal heat output Le débit calorifique nominal Nominal heat output Flusso termico nominale - CO<0,04%</p> <p>Caudal térmico reduzido Flujo térmico reducido Reduced thermal flow Flux thermique réduit Flusso termico ridotto - CO<0,06%</p>
<p>Libertação de substâncias perigosas Emisión de sustancias peligrosas Release of dangerous substances Dégagement de substances Rilascio di sostanze pericolose</p>	<p>OK. De acordo com relatório de ensaio De acuerdo com informe de la prueba According to the test report Selons le rapport d'essai Secondo i rapporto di prova CEE-0257/19-1 Rv1</p>	<p>De acordo com o Anexo ZA.1 (EN14785) De acuerdo con lo Anexo ZA.1 (EN14785) According to the Annex ZA.1 (EN14785) Selons le Annexe ZA.1 (EN14785) Secondo l'allegato ZA.1 (EN14785)</p>
<p>Temperatura de superfície Temperatura de la superficie Surface temperature La température de surface Temperatura superficiale</p>	<p>OK. De acordo com relatório de ensaio De acuerdo com informe de la prueba According to the test report Selons le rapport d'essai Secondo i rapporto di prova CEE-0257/19-1 Rv1</p>	<p>De acordo com os requisitos De acuerdo con los requisitos According to the requirements Selons les exigences Secondo i requisiti 4.2, 4.13, 5.1, 5.2, 5.4, 5.5 (EN14785)</p>
<p>Segurança eléctrica Seguridad eléctrica Electrical safety Sécurité électrique Sicurezza elettrica</p>	<p>OK. De acordo com relatório de ensaio De acuerdo com informe de la prueba According to the test report Selons le rapport d'essai Secondo i rapporto di prova CEE-0257/19-1 Rv1</p>	<p>De acordo com os requisitos De acuerdo con los requisitos According to the requirements Selons les exigences Secondo i requisiti 5.9 (EN14785)</p>
<p>Aptidão para ser limpo Capacidad para ser limpiado Ability to be cleaned Possibilité d'être nettoyé Capacità di essere puliti</p>	<p>OK. De acordo com relatório de ensaio De acuerdo com informe de la prueba According to the test report Selons le rapport d'essai Secondo i rapporto di prova CEE-0257/19-1 Rv1</p>	<p>De acordo com os requisitos De acuerdo con los requisitos According to the requirements Selons les exigences Secondo i requisiti 4.5, 4.6, 4.10, 4.12 (EN14785)</p>
<p>Temperatura dos gases de combustão Temperatura de los gases de combustión Temperature of the flue gas Température du gaz de fumée Temperatura dato fumi</p>	<p>OK. 108 °C</p>	<p>De acordo com os requisitos De acuerdo con los requisitos According to the requirements Selons les exigences Secondo i requisiti 6.2 (EN14785)</p>
<p>Resistência mecânica Resistencia mecánica Mechanical strength résistance Resistenza meccanico</p>	<p>OK. De acordo com relatório de ensaio De acuerdo com informe de la prueba According to the test report Selons le rapport d'essai Secondo i rapporto di prova CEE-0257/19-1 Rv1 A cada 10 m de conduta de fumos deve ser colocado um suporte de carga cada 10 m de la salida de humos se debe colocar un soporte de carga every 10 m of the flue should be placed a load support tous les 10 m de conduit de fumée doit être placé un support de charge ogni 10 m della canna fumaria deve essere posto un supporto di carico</p>	<p>De acordo com os requisitos De acuerdo con los requisitos According to the requirements Selons les exigences Secondo i requisiti 4.2, 4.3(EN14785)</p>

Potência térmica nominal Potencia térmica nominal Nominal Thermic output Puissance thermique nominale Potenza térmica nominale	OK. 13 kW	De acordo com os requisitos De acuerdo con los requisitos According to the requirements Selons les exigences Secondo i requisiti 6.1, 6.4 - 6.10 (EN14785)
Potência térmica reduzida Potencia térmica reducida Reduced Thermic output Puissance thermique réduite Potenza térmica ridotta	OK. 5 kW	De acordo com os requisitos De acuerdo con los requisitos According to the requirements Selons les exigences Secondo i requisiti 6.1, 6.4 - 6.10 (EN14785)
Rendimento energético Eficiencia energética Energy efficiency L'efficacité énergétique Efficienza energetica	OK. 92 %	≥ 75% para potência térmica nominal de potencia térmica nominal for rated thermal input Pour puissance thermique nominale di potenza termica nominale
	OK. 95 %	≥ 70% para potência térmica reduzida la reducción térmica to reduced thermal à la réduction thermique di potenza térmica ridotto
Durabilidade Durabilidad Durability Durabilité Durabilità	OK. De acordo com relatório de ensaio De acuerdo com informe de la prueba According to the test report Selons le rapport d'essai Secondo i rapporto di prova CEE-0257/19-1 Rv1	De acordo com os requisitos De acuerdo con los requisitos According to the requirements Selons les exigences Secondo i requisiti 4.2 (EN14785)

10. Distância mínima a materiais combustíveis (laterais/frente/topo/posterior) | Distancia mínima a materiales combustibles (laterales/frente/topo/trasero) | Minimum distance to combustible materials (side/front/top/back) | Distance minimale aux matériaux combustibles (côte/avanta/haut/arrière) | Distanza minima da materiali combustibili (lato/anteriore/top/posteriore)

(500 mm / 1500 mm / 1000 mm / 300 mm)

11. O desempenho do produto declarado nos pontos 1 e 2 é conforme com o desempenho declarado no ponto 9. A presente declaração de desempenho é emitida sob exclusiva responsabilidade do fabricante identificado no ponto 4. | El funcionamiento del producto se indica en los puntos 1 y 2 es compatible con las prestaciones declaradas en el punto 9. La presente declaración se expide bajo la exclusiva responsabilidad del fabricante identificado en lo punto 4. | Performance of the product stated in points 1 and 2 is consistent with the declared performance in point 9. This declaration of performance is issued under the sole responsibility of the manufacturer identified in point 4. | Les performances du produit indiqué dans les points 1 et 2 est compatible avec les performances declares au point 9. Cette declaration de performance est établie sous la seule responsabilité du fabricant identifié dans le point 4. | Le prestazioni dei prodotti indicati ai punti 1 e 2 è conforme alla prestazione dichiarata al punto 9. Questa dichiarazione di prestazione è rilasciata sotto l'esclusiva responsabilità del fabbricante di cui al punto 4

Nome e cargo | Nombre y cargo | Name and title | Nom et titre | Nome e titolo
Nuno Sequeira (Director Geral | CEO)

Aguada de Cima, 15/06/2020

**DECLARAÇÃO DE DESEMPENHO | DECLARACIÓN PRESTACIONES | DECLARATION OF PERFORMANCE |
DÉCLARATION DE PERFORMANCE | DICHIARAZIONE DELLE PRESTAZIONI**

Nº DD-071

1. Código de identificação único do produto-tipo | Código de identificación único del tipo de producto | Unique identification code of the product type | Le code d'identification unique du type de produit | Codice unico di identificazione del tipo di prodotto

HIDRO 17 kW – EAN 05600990463455
HIDRO 17 kW PORTA VIDRO – EAN 05600990463462

2. Número do tipo, lote ou série do produto | Número de tipo, lote o serie del producto | Number of type, batch or serial product | Nombre de type, de lot ou de série du produit | Numero di tipo, di lotto, di serie del prodotto

3. Utilização prevista | Uso previsto | Intended use | Utilisation prévue | Destinazione d'uso

AQUECIMENTO DE EDIFÍCIOS DE HABITAÇÃO COM POSSIBILIDADE DE FORNECIMENTO DE ÁGUA QUENTE | CALEFACCIÓN DE EDIFÍCIOS RESIDENCIALES COM POSIBILIDAD DE SUMINISTRO DE AGUA CALIENTE | HEATING OF RESIDENTIAL BUILDINGS WITH POSSIBILITY OF HOT WATER SUPPLY | CHAUFFAGE DE BATIMENTS RESIDENTIELS AVEC LA POSSIBILITÉ DE L'APPROVISIONNEMENT EN EAU CHAUDE | RISCALDAMENTO DEGLI EDIFICI RESIDENZIALI CON POSSIBILITÀ DI ACQUA CALDA

4. Nome, designação comercial registada e endereço de contacto do fabricante | Nombre, marca registrada y la dirección de contacto de lo fabricante | Name, registered trade name and contact address of the manufacturer | Nom, marque déposée et l'adresse de contact du fabricant | Nome, denominazione commerciale registrata e Indirizzo del costruttore

SOLZAIMA, SA
RUA DA COVA DA AREIA (E.M. 605), 695
3750-071 AGUADA DE CIMA – ÁGUEDA – PORTUGAL

5. Sistema de avaliação e verificação da regularidade do desempenho do produto | Sistema de evaluación y verificación de constancia de las prestaciones del producto | System of assessment and verification of constancy of the product | Système d'évaluation et de vérification de la Constance des performances du produit | Sistema di valutazione e verifica della costanza della prestazione del prodotto

SISTEMA 3

6. Norma Harmonizada | Estandár armonizado | Harmonized standard | Norme harmonisée | Standard armonizzata

EN 14785

7. Nome e número de identificação do organismo notificado | Nombre y número de identificación del organismo notificado | Name and identification number of the notified body | Nom et numéro d'identification de l'organisme notifié | Nome e numero di identificazione dell'organismo notificato

TÜV RHEINLAND INDUSTRIE SERVICE GMBH - TÜV Rheinland Group

NB: 2456

CEIS

NB: 1722

8. Relatório de ensaio | Informe de la prueba | Test report | Rapport d'essai | Rapporto di prova

K15032015TI
CEE-0257/19-1 RV1

<p>Características essenciais Características esenciales Essencial characteristics Caractéristiques essentiellles Caratteristiche essenziali</p>	<p>Desempenho Desempeño Performance Prestazione</p>	<p>Especificações técnicas harmonizadas Especificaciones técnicas armonizadas Harmonized technical specifications Spécifications techniques harmonisées Specifiche tecniche armonizzate</p>
<p>Segurança contra incêndio Seguridad contra incendios Fire safety Sécurité incendie Sicurezza antincendio</p>	<p>OK. De acordo com relatório de ensaio De acuerdo com informe de la prueba According to the test report Selons le rapport d'essai Secondo i rapporto di prova K15032015T1 CEE-0257/19-1 Rv1</p>	<p>De acordo com os requisitos De acuerdo con los requisitos According to the requirements Selons les exigences Secondo i requisiti 4.2, 4.3, 4.7, 4.8, 4.10, 4.11, 5.1, 5.3, 5.4, 5.5, 5.8 (EN14785)</p>
<p>Emissão de produtos da combustão La emisión de productos de combustión Emission of combustion products Emission des produits de combustion Emissione dei prodotti di combustione</p>	<p>OK. Caudal térmico nominal Caudal térmico nominal Nominal heat output Le débit calorifique nominal Nominal heat output Flusso termico nominale – CO:0,0162%</p>	<p>Caudal térmico nominal Caudal térmico nominal Nominal heat output Le débit calorifique nominal Nominal heat output Flusso termico nominale –CO<0,04%</p>
	<p>OK. Caudal térmico reduzido Flujo térmico reducido Reduced thermal flow Flux thermique réduit Flusso termico ridotto –CO: 0,0200%</p>	<p>Caudal térmico reduzido Flujo térmico reducido Reduced thermal flow Flux thermique réduit Flusso termico ridotto – CO<0,06%</p>
<p>Libertação de substâncias perigosas Emisión de sustancias peligrosas Release of dangerous substances Dégagement de substances Rilascio di sostanze pericolose</p>	<p>OK. De acordo com relatório de ensaio De acuerdo com informe de la prueba According to the test report Selons le rapport d'essai Secondo i rapporto di prova K15032015T1 CEE-0257/19-1 Rv1</p>	<p>De acordo com o Anexo ZA.1 (EN14785) De acuerdo con lo Anexo ZA.1 (EN14785) According to the Annex ZA.1 (EN14785) Selons le Annexe ZA.1 (EN14785) Secondo l'allegato ZA.1 (EN14785)</p>
<p>Temperatura de superfície Temperatura de la superficie Surface temperature La température de surface Temperatura superficiale</p>	<p>OK. De acordo com relatório de ensaio De acuerdo com informe de la prueba According to the test report Selons le rapport d'essai Secondo i rapporto di prova K15032015T1 CEE-0257/19-1 Rv1</p>	<p>De acordo com os requisitos De acuerdo con los requisitos According to the requirements Selons les exigences Secondo i requisiti 4.2, 4.13, 5.1, 5.2, 5.4, 5.5 (EN14785)</p>
<p>Segurança eléctrica Seguridad eléctrica Electrical safety Sécurité électrique sicurezza elettrica</p>	<p>OK. De acordo com relatório de ensaio De acuerdo com informe de la prueba According to the test report Selons le rapport d'essai Secondo i rapporto di prova K15032015T1 CEE-0257/19-1 Rv1</p>	<p>De acordo com os requisitos De acuerdo con los requisitos According to the requirements Selons les exigences Secondo i requisiti 5.9 (EN14785)</p>
<p>Aptidão para ser limpo Capacidad para ser limpiado Ability to be cleaned Possibilité d'être nettoyé Capacità di essere puliti</p>	<p>OK. De acordo com relatório de ensaio De acuerdo com informe de la prueba According to the test report Selons le rapport d'essai Secondo i rapporto di prova K15032015T1 CEE-0257/19-1 Rv1</p>	<p>De acordo com os requisitos De acuerdo con los requisitos According to the requirements Selons les exigences Secondo i requisiti 4.5, 4.6, 4.10, 4.12 (EN14785)</p>
<p>Temperatura dos gases de combustão Temperatura de los gases de combustión Temperature of the flue gas Température du gaz de fumée Temperatura dato fumi</p>	<p>OK. 126,51 °C</p>	<p>De acordo com os requisitos De acuerdo con los requisitos According to the requirements Selons les exigences Secondo i requisiti 6.2 (EN14785)</p>

Resistência mecânica Resistencia mecânica Mechanical strength résistance Resistenza meccanico	OK. De acordo com relatório de ensaio De acuerdo com informe de la prueba According to the test report Selons le rapport d'essai Secondo i rapporto di prova K15032015T1 CEE-0257/19-1 Rv1 A cada 10 m de conduta de fumos deve ser colocado um suporte de carga cada 10 m de la salida de humos se debe colocar un soporte de carga every 10 m of the flue should be placed a load support tous les 10 m de conduit de fumée doit être placé un support de charge ogni 10 m della canna fumaria deve essere posto un supporto di carico	De acordo com os requisitos De acuerdo con los requisitos According to the requirements Selons les exigences Secondo i requisiti 4.2, 4.3(EN14785)
Potência térmica nominal Potencia térmica nominal Nominal Thermic output Puissance thermique nominale Potenza térmica nominale	OK. 16,7 kW	De acordo com os requisitos De acuerdo con los requisitos According to the requirements Selons les exigences Secondo i requisiti 6.1, 6.4 - 6.10 (EN14785)
Potência térmica reduzida Potencia térmica reducida Reduced Thermic output Puissance thermique réduite Potenza térmica ridotta	OK. 5,1 kW	De acordo com os requisitos De acuerdo con los requisitos According to the requirements Selons les exigences Secondo i requisiti 6.1, 6.4 - 6.10 (EN14785)
Rendimento energético Eficiencia energética Energy efficiency L'efficacité énergétique Efficienza energetica	OK. 90,85 %	≥ 75% para potência térmica nominal de potencia térmica nominal for rated thermal input Pour puissance thermique nominale di potenza termica nominale
	OK. 93,80 %	≥ 70% para potência térmica reduzida la reducción térmica to reduced thermal à la réduction thermique di potenza térmica ridotto
Durabilidade Durabilidad Durability Durabilité Durabilità	OK. De acordo com relatório de ensaio De acuerdo com informe de la prueba According to the test report Selons le rapport d'essai Secondo i rapporto di prova K15032015T1 CEE-0257/19-1 Rv1	De acordo com os requisitos De acuerdo con los requisitos According to the requirements Selons les exigences Secondo i requisiti 4.2 (EN14785)

10. Distância mínima a materiais combustíveis (laterais/frente/topo/posterior) | Distancia mínima a materiales combustibles (laterales/frente/topo/trasero) | Minimum distance to combustible materials (side/front/top/back) | Distance minimale aux matériaux combustibles (côte/avanta/haut/arrière) | Distanza mínima da materiali combustibili (lato/anteriore/top/posteriore)

(500 mm / 1500 mm / 1000 mm / 300 mm)

11. O desempenho do produto declarado nos pontos 1 e 2 é conforme com o desempenho declarado no ponto 9. A presente declaração de desempenho é emitida sob exclusiva responsabilidade do fabricante identificado no ponto 4. | El funcionamiento del producto se indica en los puntos 1 y 2 es compatible con las prestaciones declaradas en el punto 9. La presente declaración se expide bajo la exclusiva responsabilidad del fabricante identificado en lo punto 4. | Performance of the product stated in points 1 and 2 is consistent with the declared performance in point 9. This declaration of performance is issued under the sole responsibility of the manufacturer identified in point 4. | Les performances du produit indiqué dans les points 1 et 2 est compatible avec les performances declares au point 9. Cette declaration de performance est établie sous la seule responsabilité du fabricant identifié dans le point 4. | Le prestazioni dei prodotti indicati ai punti 1 e 2 è conforme alla prestazione dichiarata al punto 9. Questa dichiarazione di prestazione è rilasciata sotto l'esclusiva responsabilità del fabbricante di cui al punto 4.

Nome e cargo | Nombre y cargo | Name and title | Nom et titre | Nome e titolo
Nuno Sequeira (Director Geral | CEO)

Aguada de Cima, 15/06/2020

**DECLARAÇÃO DE DESEMPENHO | DECLARACIÓN PRESTACIONES | DECLARATION OF PERFORMANCE |
DÉCLARATION DE PERFORMANCE | DICHIARAZIONE DELLE PRESTAZIONI**

Nº DD-072

1. Código de identificação único do produto-tipo | Código de identificación único del tipo de producto | Unique identification code of the product type | Le code d'identification unique du type de produit | Codice unico di identificazione del tipo di prodotto

HIDRO 23 kW – EAN 05600990463479

HIDRO 23 kW PORTA EM VIDRO – EAN 05600990463486

2. Número do tipo, lote ou série do produto | Número de tipo, lote o serie del producto | Number of type, batch or serial product | Nombre de type, de lot ou de série du produit | Numero di tipo, di lotto, di serie del prodot

3. Utilização prevista | Uso previsto | Intended use | Utilisation prévue | Destinazione d'uso

AQUECIMENTO DE EDIFÍCIOS DE HABITAÇÃO COM POSSIBILIDADE DE FORNECIMENTO DE ÁGUA QUENTE | CALEFACCIÓN DE EDIFÍCIOS RESIDENCIALES COM POSIBILIDAD DE SUMINISTRO DE AGUA CALIENTE | HEATING OF RESIDENTIAL BUILDINGS WITH POSSIBILITY OF HOT WATER SUPPLY | CHAUFFAGE DE BATIMENTS RESIDENTIELS AVEC LA POSSIBILITÉ DE L'APPROVISIONNEMENT EN EAU CHAUDE | RISCALDAMENTO DEGLI EDIFICI RESIDENZIALI CON POSSIBILITÀ DI ACQUA CALDA

4. Nome, designação comercial registada e endereço de contacto do fabricante | Nombre, marca registrada y la dirección de contacto de lo fabricante | Name, registered trade name and contact address of the manufacturer | Nom, marque déposée et l'adresse de contact du fabricant | Nome, denominazione commerciale registrata e Indirizzo del costruttore

SOLZAIMA, SA

RUA DA COVA DA AREIA (E.M. 605), 695

3750-071 AGUADA DE CIMA – ÁGUEDA – PORTUGAL

5. Sistema de avaliação e verificação da regularidade do desempenho do produto | Sistema de evaluación y verificación de constancia de las prestaciones del producto | System of assessment and verification of constancy of the product | Système d'évaluation et de vérification de la Constance des performances du produit | Sistema di valutazione e verifica della costanza della prestazione del prodotto

SISTEMA 3

6. Norma Harmonizada | Estandár armonizado | Harmonized standard | Norme harmonisée | Standard armonizzata

EN 14785

7. Nome e número de identificação do organismo notificado | Nombre y número de identificación del organismo notificado | Name and identification number of the notified body | Nom et numéro d'identification de l'organisme notifié | Nome e numero di identificazione dell'organismo notificato

TÜV RHEINLAND INDUSTRIE SERVICE GMBH - TÜV Rheinland Group

NB: 2456

8. Relatório de ensaio | Informe de la prueba | Test report | Rapport d'essai | Rapporto di prova

K15032015TI

9. Desempenho declarado | Desempeño declarado | Declared performance | Performance déclarée | Dichiarazione di prestazione

<p>Características essenciais Características esenciales Essential characteristics Caractéristiques essentielles Caratteristiche essenziali</p>	<p>Desempenho Desempeño Performance Prestazione</p>	<p>Especificações técnicas harmonizadas Especificaciones técnicas armonizadas Harmonized technical specifications Spécifications techniques harmonisées Specifiche tecniche armonizzate</p>
<p>Segurança contra incêndio Seguridad contra incendios Fire safety Sécurité incendie Sicurezza antincendio</p>	<p>OK. De acordo com relatório de ensaio De acuerdo com informe de la prueba According to the test report Selons le rapport d'essai Secondo i rapporto di prova K15032015T1</p>	<p>De acordo com os requisitos De acuerdo con los requisitos According to the requirements Selons les exigences Secondo i requisiti 4.2, 4.3, 4.7, 4.8, 4.10, 4.11, 5.1, 5.3, 5.4, 5.5, 5.8 (EN14785)</p>
<p>Emissão de produtos da combustão La emisión de productos de combustión Emission of combustion products Emission des produits de combustion Emissione dei prodotti di combustione</p>	<p>OK. Caudal térmico nominal Caudal térmico nominal Nominal heat output Le débit calorifique nominal Nominal heat output Flusso termico nominale – CO:0,0195%</p>	<p>Caudal térmico nominal Caudal térmico nominal Nominal heat output Le débit calorifique nominal Nominal heat output Flusso termico nominale – CO<0,04%</p>
	<p>OK. Caudal térmico reduzido Flujo térmico reducido Reduced thermal flow Flux thermique réduit Flusso termico ridotto – CO: 0,024%</p>	<p>Caudal térmico reduzido Flujo térmico reducido Reduced thermal flow Flux thermique réduit Flusso termico ridotto – CO<0,06%</p>
<p>Libertação de substâncias perigosas Emisión de sustancias peligrosas Release of dangerous substances Dégagement de substances Rilascio di sostanze pericolose</p>	<p>OK. De acordo com relatório de ensaio De acuerdo com informe de la prueba According to the test report Selons le rapport d'essai Secondo i rapporto di prova K15032015T1</p>	<p>De acordo com o Anexo ZA.1 (EN14785) De acuerdo con lo Anexo ZA.1 (EN14785) According to the Annex ZA.1 (EN14785) Selons le Annexe ZA.1 (EN14785) Secondo l'allegato ZA.1 (EN14785)</p>
<p>Temperatura de superfície Temperatura de la superficie Surface temperature La température de surface Temperatura superficiale</p>	<p>OK. De acordo com relatório de ensaio De acuerdo com informe de la prueba According to the test report Selons le rapport d'essai Secondo i rapporto di prova K15032015T1</p>	<p>De acordo com os requisitos De acuerdo con los requisitos According to the requirements Selons les exigences Secondo i requisiti 4.2, 4.13, 5.1, 5.2, 5.4, 5.5 (EN14785)</p>
<p>Segurança eléctrica Seguridad eléctrica Electrical safety Sécurité électrique Sicurezza elettrica</p>	<p>OK. De acordo com relatório de ensaio De acuerdo com informe de la prueba According to the test report Selons le rapport d'essai Secondo i rapporto di prova K15032015T1</p>	<p>De acordo com os requisitos De acuerdo con los requisitos According to the requirements Selons les exigences Secondo i requisiti 5.9 (EN14785)</p>
<p>Aptidão para ser limpo Capacidad para ser limpiado Ability to be cleaned Possibilité d'être nettoyé Capacità di essere puliti</p>	<p>OK. De acordo com relatório de ensaio De acuerdo com informe de la prueba According to the test report Selons le rapport d'essai Secondo i rapporto di prova K15032015T1</p>	<p>De acordo com os requisitos De acuerdo con los requisitos According to the requirements Selons les exigences Secondo i requisiti 4.5, 4.6, 4.10, 4.12 (EN14785)</p>
<p>Pressão máxima de serviço Presión máxima de trabajo Maximum working pressure Pression de service maximale Pressione massima di esercizio</p>	<p>OK. 2,8 bar</p>	<p>De acordo com os requisitos De acuerdo con los requisitos According to the requirements Selons les exigences Secondo i requisiti 4.2, 5.6,5,7 (EN14785)</p>
<p>Temperatura dos gases de combustão Temperatura de los gases de combustión Temperature of the flue gas Température du gaz de fumée Temperatura dato fumi</p>	<p>OK. 153°C</p>	<p>De acordo com os requisitos De acuerdo con los requisitos According to the requirements Selons les exigences Secondo i requisiti 6.2 (EN14785)</p>

Resistência mecânica Resistencia mecânica Mechanical strength résistance Resistenza meccanico	OK. De acordo com relatório de ensaio De acuerdo com informe de la prueba According to the test report Selons le rapport d'essai Secondo i rapporto di prova K15032015T1 A cada 10 m de conduta de fumos deve ser colocado um suporte de carga cada 10 m de la salida de humos se debe colocar un soporte de carga every 10 m of the flue should be placed a load support tous les 10 m de conduit de fumée doit être placé un support de charge ogni 10 m della canna fumaria deve essere posto un supporto di carico	De acordo com os requisitos De acuerdo con los requisitos According to the requirements Selons les exigences Secondo i requisiti 4.2, 4.3(EN14785)
Potência térmica Potencia térmica Thermic output Puissance thermique Potenza termico	OK. 23 KW	De acordo com os requisitos De acuerdo con los requisitos According to the requirements Selons les exigences Secondo i requisiti 6.1, 6.4 - 6.10 (EN14785)
Rendimento energético Eficiencia energética Energy efficiency L'efficacité énergétique Efficienza energetica	OK. 89,2%	≥ 75% para potência térmica nominal de potencia térmica nominal for rated thermal input Pour puissance thermique nominale di potenza termica nominale
	OK. 93,8%	≥ 70% para potência térmica reduzida la reducción térmica to reduced thermal à la réduction thermique di potenza térmica ridotto
Durabilidade Durabilidad Durability Durabilité Durabilità	OK. De acordo com relatório de ensaio De acuerdo com informe de la prueba According to the test report Selons le rapport d'essai Secondo i rapporto di prova K15032015T1	De acordo com os requisitos De acuerdo con los requisitos According to the requirements Selons les exigences Secondo i requisiti 4.2 (EN14785)

10. Distância mínima a materiais combustíveis (laterais/frente/topo/posterior) | Distancia mínima a materiales combustibles (laterales/frente/topo/trasero) | Minimum distance to combustible materials (side/front/top/back) | Distance minimale aux matériaux combustibles (côte/avanta/haut/arrière) | Distanza minima da materiali combustibili (lato/antieriore/top/posteriore)

(200 mm/1500 mm/1000 mm/200 mm)

11. O desempenho do produto declarado nos pontos 1 e 2 é conforme com o desempenho declarado no ponto 9. A presente declaração de desempenho é emitida sob exclusiva responsabilidade do fabricante identificado no ponto 4. | El funcionamiento del producto se indica en los puntos 1 y 2 es compatible con las prestaciones declaradas en el punto 9. La presente declaración se expide bajo la exclusiva responsabilidad del fabricante identificado en lo punto 4. | Performance of the product stated in points 1 and 2 is consistent with the declared performance in point 9. This declaration of performance is issued under the sole responsibility of the manufacturer identified in point 4. | Les performances du produit indiqué dans les points 1 et 2 est compatible avec les performances declares au point 9. Cette declaration de performance est établie sous la seule responsabilité du fabricant identifié dans le point 4. | Le prestazioni dei prodotti indicati ai punti 1 e 2 è conforme alla prestazione dichiarata al punto 9. Questa dichiarazione di prestazione è rilasciata sotto l'esclusiva responsabilità del fabbricante di cui al punto 4